

VMC Vaughan Metropolitan Centre Signage and Wayfinding Master Plan

THE CYGNUS DESIGN GROUP INC.

Unit 303, 145 Front St. East, Toronto, Ontario M5A 1E3

DATE

November 28, 2024

SIGNAGE & WAYFINDING

Document Contents

Executive Summary	3	LOCATION PLANNING:	26
		Pedestrian Flow	27
THE SIGN SYSTEM:	4	Urban Loop	28
The Sign Family	5	Outer Loop	29
Wayfinding Principles	6	Additional Cycling Facilities	30
A1: Primary Pylon, Freestanding	8		
ID1: Destination ID, Wall-mounted	9	PREPARING FOR PROCUREMENT AND IMPLEMENTATION:	31
ID2: Destination ID, Freestanding, Large	10	Typical Procurement and Fabrication Schedule	32
ID3: Destination ID, Freestanding, Small	11	Sign and Maintenance Cost Estimates	33
T1: Trail Directional, Freestanding	12		
T2: Bicyclist Directional, Curb-mounted	13	APPENDIX: GRAPHIC ASSETS AND TECHNICAL DETAILS::	34
VMC Map	14	Graphic Assets: VMC Branding	35
		Graphic Assets: Colours	36
SIGN PLACEMENT AND BEST PRACTICE:	15	Graphic Assets: Typography and Pictograms	37
Guidelines and Considerations	16	A1: Technical Details	38
General Placement: Streetscape	17	ID1: Technical Details	41
General Placement: Lighting	19	ID2: Technical Details	42
General Placement: Alignment	20	ID3: Technical Details	45
General Placement: Parks and Greenspaces	21	T1: Technical Details	47
General Placement: Trails	22	T2: Technical Details	50
Obstructions	23	Powder Coating Specification & Maintenance	52
Clearance	24		
Relevant Codes	25		





SIGNAGE & WAYFINDING

Executive Summary

Document Overview

The VMC's development has and is continuing to transform the City's downtown core with the goals of embracing good urban design and providing public spaces to cultivate community well-being. As a part of this initiative, The Cygnus Design Group has been engaged to develop a signage and wayfinding system to aid in supporting these goals and encourage resident and visitor navigation throughout the VMC with a particular focus on parks, trails, and public amenities. It will enable visitors to orient themselves upon their arrival, and provide them with the tools to navigate their City centre with confidence.

The guidance provided in this document details the elements of this wayfinding system and provides advice and considerations to suit various urban conditions and is an aid for future planning as the VMC continues to develop and expand.

Summary of Strategies

The wayfinding signage in this document has been developed to support the goals and intent outlined within the VMC's Streetscape and Open Space Plan. The system best supports this plan's goal of connectivity by providing mapping tools to strengthen visitor and resident visual understanding of the area, and using directional information with approximate travel times to provide intuitive pathing and encourage travel to nearby City parks and amenities. These tools additionally help to strengthen the interconnectivity of the downtown's streetscapes and greenspaces. The wayfinding system is anticipated to additionally support the VMC Parks & Wayfinding Master Plan.

Wayfinding is a repeating cycle of orientation, direction, and confirmation to get from one's point A to their point B. In order to support public navigation throughout the VMC, a freestanding pylon sign with detailed maps, directional information, and contextual information including location name and address will be employed at key decision making points. This sign type is the core wayfinding structure that will help provide orientation and area context while also providing pathing information for people to navigate to City parks, public amenities, and other destinations. The physical design

and graphic standards of the sign type also support the goal of "Creating a Unique Identity for the VMC" from the City's Streetscape and Open Space Plan. While the functionality is similar to many other City wayfinding plans, the structural design and overall look and feel is unique to the VMC.

The VMC is anticipated to have several mews and Privately Owned Publicly-Accessible Spaces (POPS) which connect to primary paths of travel, and while they may seem private, they are open for the public to discover, explore, and experience. The entrances to these areas will be marked with small freestanding or wall-mounted signs that identify the space and confirm its openness for public discovery. These signs may carry simple map visuals and other interpretive information pertinent to the space as well.

For established pedestrian and cyclist trails, two signs have been designed to be placed at decision points in order to provide orientation and direction to nearby points of interest, and to identify the type of user for different sides of paths, where applicable. The first, a thin-profile freestanding sign that echoes the design of the map pylon will typically be placed along open greenspaces and the outer extents of the VMC. The second, a curb-mounted variation of the first will be placed in the downtown's denser areas to help minimize visual obstructions, especially near intersections.

A pilot area will first be implemented within the developed core of the VMC and is strategized to direct pedestrians to and from the transit hubs, the parks, as well as to and from other public amenities such as the library or YMCA. Learnings from the pilot are anticipated to drive future refinement and expansion of the VMC wayfinding system so that it reflects any changing needs of the community and its visitors as the area continues to grow and develop.

The Sign System



THE SIGN SYSTEM:
The Sign Family:

The VMC wayfinding sign family consists of six sign types to help residents and visitors confidently navigate the area, identify points of interest, and provide pathing for established public trails.



A1:
 Primary Pylon,
 Freestanding

ID1:
 Destination ID,
 Wall-mounted

ID2:
 Destination ID,
 Freestanding,
 Large

ID3:
 Destination ID,
 Freestanding,
 Small

T1:
 Trail Directional,
 Freestanding

T2:
 Bicyclist Directional,
 Curb-mounted

Wayfinding Principles

The following are a set of five wayfinding principles that the sign system is designed around and are essential to consider while working with this VMC Signage & Wayfinding Master Plan in order to achieve the best outcomes.

“Legibility research at the Pennsylvania State University has shown that inconsistent and cluttered environments can adversely affect viewer legibility and vehicular safety by relaying too many incomplete and ineffective messages.”

— Sign Research Foundation.

1

CONSISTENCY

Sign types within a wayfinding sign family share a consistent look and feel so that each component is recognizably connected. This consistency creates a sense of predictability for users making it easier to search and find relevant signs as the user navigates an area, as well as where to find key information on each sign.

Specific information on signage such as destination nomenclature and addresses should also aim to be consistent with how it’s presented throughout and beyond the signage system. This might include City websites, other collateral information, and how areas are identified at the destination themselves.

2

USER-FOCUSED

Wayfinding information should be focused on helping users navigate an area, and be accessible to as many users as possible in its performance. As such, sign content and sign locations should meet or exceed AODA requirements, the Vaughan Inclusive Design Standard, and other applicable standards. Various levels of abilities should be considered when planning including physical access, eyesight and legibility, language, cognitive limitations, as well as cultural background and context.

Signs should also be user-focused in terms of content by avoiding unnecessary information that requires additional time to process and interpret, and by abstaining from including any disruptive elements (e.g. advertising) that are not relevant to the wayfinding purpose.

3

INTERCONNECTED

As wayfinding is a repeating cycle of orientation, direction, and confirmation to get from place to place, all components of a wayfinding system must work together in order to support this cycle. Maps provide abstract information for orientation and support the development of a user’s mental map for the local area. Directional components help navigation by providing clear pathing to notable destinations. Any contextual information on signage such as destination names or addresses further confirms an individual's current location or arrival.

Because of this interconnectivity, each sign cannot be looked at singularly, but as part of a larger system, a network of information and pathing.

4

SIMPLIFIED

It’s best to keep things simple. Display only the content that is strictly necessary and remove any excess information. Messaging and visual cues should be curated to be appropriate for every decision point, and be written in plain language so as not overwhelm users. The more information that is present, the less likely a visitor will take the time to interpret it—a key reason for the well-known adage, “less is more”.

Similarly, when considering locations for new signs, it is best to simplify and consolidate existing signs and messaging to declutter the area whenever possible, and to streamline what is being conveyed about the area in a consistent manner.

5

PROGRESSIVE DISCLOSURE

The wayfinding system should provide a breadcrumb trail with each “crumb” along the journey providing just enough information to navigate to the next. This requires particular consideration in planning phases to ensure relevant information is being conveyed at the appropriate time and place without overwhelming a user with too much information.

Whenever a sign provides directions to a specific destination, all other directional signs along the path of travel must continue to list that same destination to complete the breadcrumb trail. This is to ensure no user becomes lost or confused mid-route.

THE SIGN SYSTEM

Nomenclature and Destination Eligibility

There are many potential destinations to list on signage, and each sign type will have a limit as to how many can be conveyed. This page outlines guidelines to help keep nomenclature brief and guidance on how to prioritize eligible destinations when thresholds are exceeded.

NOMENCLATURE

All destinations on map and directional signage should meet certain conditions in order to be as unambiguous as possible.

As such, all nomenclature should:

- Be as concise as possible using the fewest number of words to distinguish the destination;
- Be consistent across signage, as well as on-site, online, and in any City collateral wherever possible;
- Be unique and discernible.
- Be recognizable by a local person in the street;
- Be recognizable by someone who is unfamiliar with the destination. New or small destinations may be exempt from this depending on their context.
- Avoid acronyms unless they are publicly well known.

ELIGIBILITY

General Requirements

There are many destinations across the region that could be included in the sign system but accommodating everyone and everything is neither feasible nor practical. Each sign will have an established threshold for how many destinations it can convey and so a strategy will need to be developed and agreed upon in order to limit the number of per sign location and to rank them when those thresholds are exceeded.

Destinations on pedestrian signage should fall into agreed-upon categories. These might include:

- Significant City areas (established districts and other well-known nodes).
- Public amenities (e.g. washrooms, drinking fountains, etc).
- Parks, beaches, gardens, and notable public spaces
- Historical, Cultural, or Indigenous buildings or sites.
- Transportation hubs (e.g. bus stations, subway station, etc).
- Sports venues attracting large numbers of spectators or users each year.

- Art related centres or spaces with high visitation.
- Convention centres, event halls, community centres, and similar spaces with high visitation.
- Community Centres, Libraries, Institute of Higher Learning.
- Religious venues open to the general public.
- Malls and notable shopping centres/districts.

Principles for Eligibility

Principles for eligibility should require destinations, where possible, to:

- Serve transient visitors.
- Be open to the general public.
- Be accessible by public roads.
- Remain open for an acceptable portion of the year. (e.g. 5 days a week for a minimum of 12 consecutive weeks).
- Have prominent signage identifying the destination that is visible from the nearest public roadway.
- The location is actively advertised, including its location and operating dates/times. This may be done through physical or online tourism publications, by local or provincial travel information centres, or through other means acceptable to the City (e.g. business sites, social media, etc).
- Have one or more of these tourist-oriented facilities:
 - a reception structure, staffed reception, or point of orientation;
 - a controlled gate;
 - permanent interpretation panels or displays.
- The destination and its operations must be compliant with all federal, provincial, and municipal legislations where applicable.

How to Prioritize Destinations Listings

When the number of eligible destinations exceeds the threshold on a sign, rank and prioritize the destinations based on the following:

- 1) As one of the goals for developing the VMC wayfinding system is to improve visitation and user access to various parks and commercial destinations,

potential listings can be ranked by either:

- total number of annual visitations; or
 - the value of visitor expenditure directly related to the destination, or indirectly to other nearby businesses as a result of visitation to that destination (e.g. notable public spaces).
- 2) Proximity of the destination from the sign location. Closer destinations should typically have priority over those farther away.
 - 3) An additional consideration on a case-by-case basis would be the destination's overall usefulness to the general public in terms of wayfinding and navigating the City.

Destinations to Avoid

Private businesses, shops, restaurants, and similar destinations are not recommended to be eligible for signing. They have high turnover rates which would cause a frequent need to update signage, and typically are not as impactful when it comes to wayfinding or tourism. However, identifying the bigger impact destinations and clarifying the areas around private businesses through maps and wayfinding signage should indirectly increase their visitation with increased pedestrian circulation.

Re-evaluating Eligibility

It is recommended that the VMC periodically reevaluate the eligibility criteria for the sign system every couple of years to ensure the program is practically serving its purpose and is optimized for success. The eligibility system should be designed in a way that can easily accommodate changes for accuracy and to optimize the tourism experience throughout the City. Any policies or agreements with non-City owned destinations should limit any promises for presence on a sign for any length of time greater than 2–3 years.

THE SIGN SYSTEM

A1: Primary Pylon, Freestanding

Large, double-sided pylon with area identification and a map directory to orient pedestrians and support them in navigating and understanding the bounds of the VMC.

Sign features:

- 1: Map showing an overview of the entire VMC, map legend, scale, and north markers.
- 2: Simple directional information to nearby parks and major amenities with average walking times.
- 3: Name of park, area, or transit.
- 4: Name of Urban 'zone'.
- 5: Nearby address or point of reference to convey to EMS in case of emergency.
- 6: QR Code to City website.
- 7: VMC branding.

Typical locations:

- Key entry points into the VMC (e.g. transit hubs, pedestrian entries at region's boundaries, etc).
- Near major intersections.

Additional Information:

- The sign should be rotated so that the sign face is perpendicular to the flow of pedestrian traffic, with the white fin closest to the road. At entrances to parks and other greenspaces, the fin should be positioned where the name of the park will be the most visible to entering traffic from its location.
- There should be a minimum 1500mm of clearance around the sign.

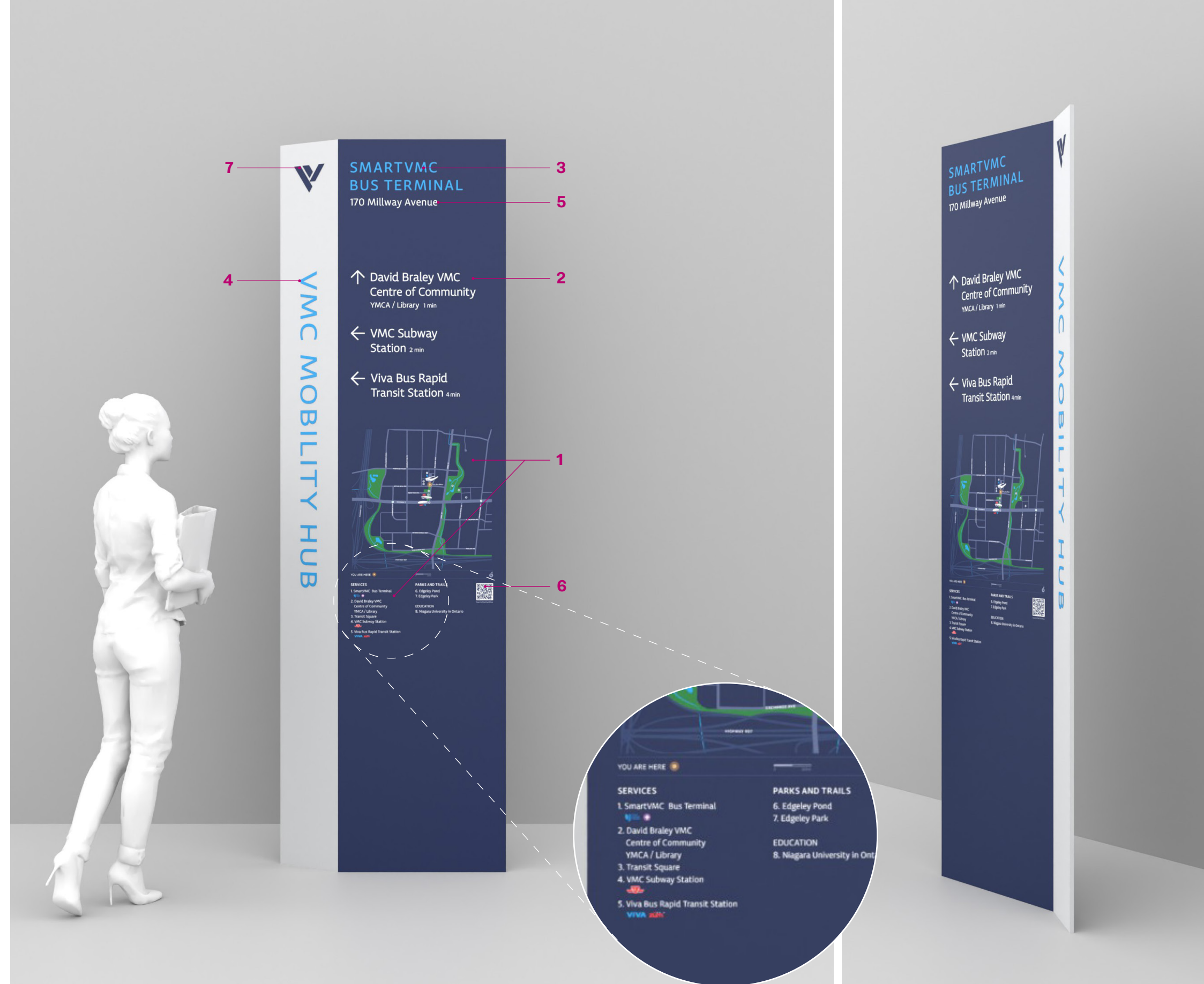

THE SIGN SYSTEM

ID1: Destination ID, Wall-mounted

A wall-mounted sign that identifies publicly accessible areas, such as a mews or POPS, and may provide interpretive information to the reader about the site location, history, proposed amenity features etc.

Sign features:

- 1 Identification for the mews or POPS area, including its address.
- 2 Interpretive information (optional).
- 3 Graphic Layout Plan of the proposed public space.
- 4 QR Code to City website.
- 5 VMC branding.

Typical locations:

On a wall surface near entries into mews and POPS. If a wall-surface isn't available, an ID2 or ID3 sign may be used instead.

Additional information:

Keep a clear space of at least 2m around the sign.

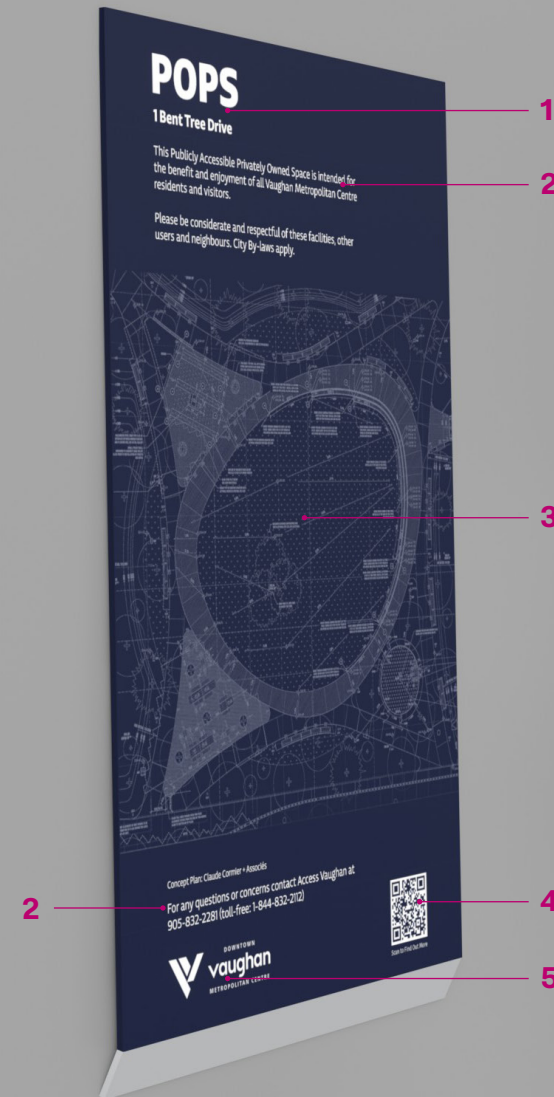

THE SIGN SYSTEM

ID2: Destination ID, Freestanding, Large

A freestanding version of the ID1 sign type for when a wall location isn't available or when it is not the best option for the space.

Sign features:

- 1 Identification for the mews or POPS area, including its address.
- 2 Interpretive information (optional).
- 3 Graphic layout plan of the proposed public space.
- 4 QR Code to City website.
- 5 VMC branding.

Typical locations:

Located near entries into a mews or POPS where it is clearly visible, but not an obstacle to pedestrian traffic in the area. If a viable location isn't available (e.g. the sign blocks the pedestrian clear path), and ID1 or ID3 sign may be used in its place.

Additional information:

Keep a clear space of at least 1.5m around the front and sides of the sign. The rear side of the sign may abut an adjacent wall or hardscape feature.

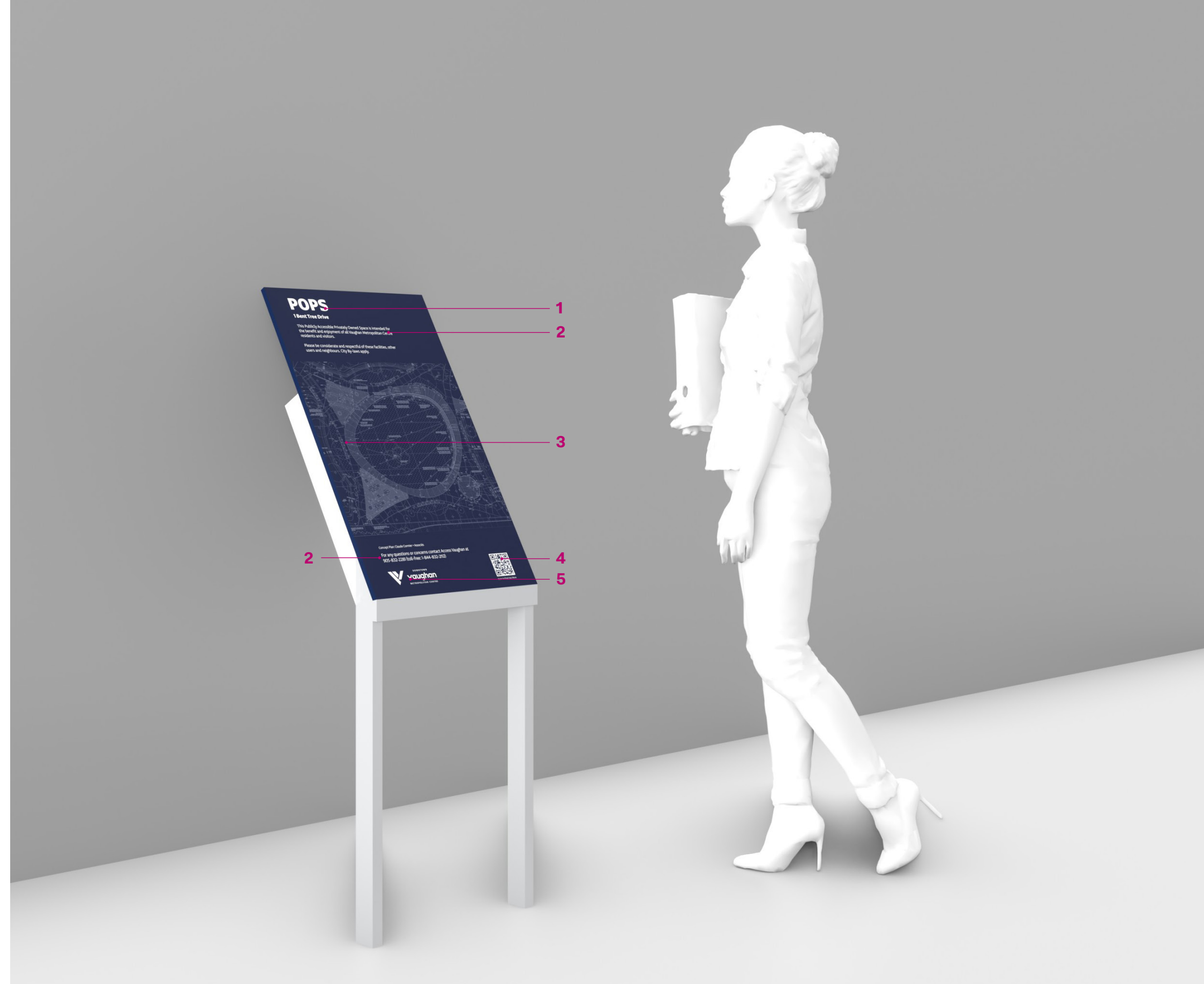

THE SIGN SYSTEM

ID3: Destination ID, Freestanding, Small

A smaller version of the ID2 sign type for when the space is less prominent, or the pathway requires a smaller scaled sign to fit within the site context.

Sign features:

- 1 Identification for the mews or POPS area, including its address.
- 2 Interpretive information (optional).
- 3 Graphic layout plan of the proposed public space.
- 4 QR Code to City website.
- 5 VMC branding.

Typical locations:

Located near entries into a mews or POPs where it is visible, but not an obstacle to pedestrian traffic in the area. ID3 may be used instead of a ID2, if a smaller profile sign is more desirable due to site context.

Additional information:

Keep a clear space of at least 1.5m around the front and sides of the sign. The rear side of the sign may abut an adjacent wall or hardscape feature.



THE SIGN SYSTEM

T1: Trail Directional, Freestanding

These signs are positioned along pedestrian and cyclist trail routes intended to provide directions to nearby parks and amenities, and assist in navigating along the established trail. The sign may also be used on curb-less routes where installation of a T2 sign is not feasible.

Sign features:

- 1 Identification of the trail or area.
- 2 Identifies permitted trail users, and where applicable, to which trail lane they should be using.
- 3 Simple directional information to nearby parks and major amenities with average walking times.

Typical locations:

Placed at decision points along established City trails where the path is disrupted by a road or an intersecting trail, and/or to clarify when the path changes direction. The T1 sign is best suited for more open areas such as along the VMC's Outer Loop trail, or along trails within parks and greenspaces.

Additional Information:

- The sign should be rotated so that the sign face is perpendicular to the trail and its traffic, with the small angled panel positioned closest to the path.
- Should have a minimum 500mm of clearance to each side of the sign with an exception of 1000mm to the curb of a road, if applicable.

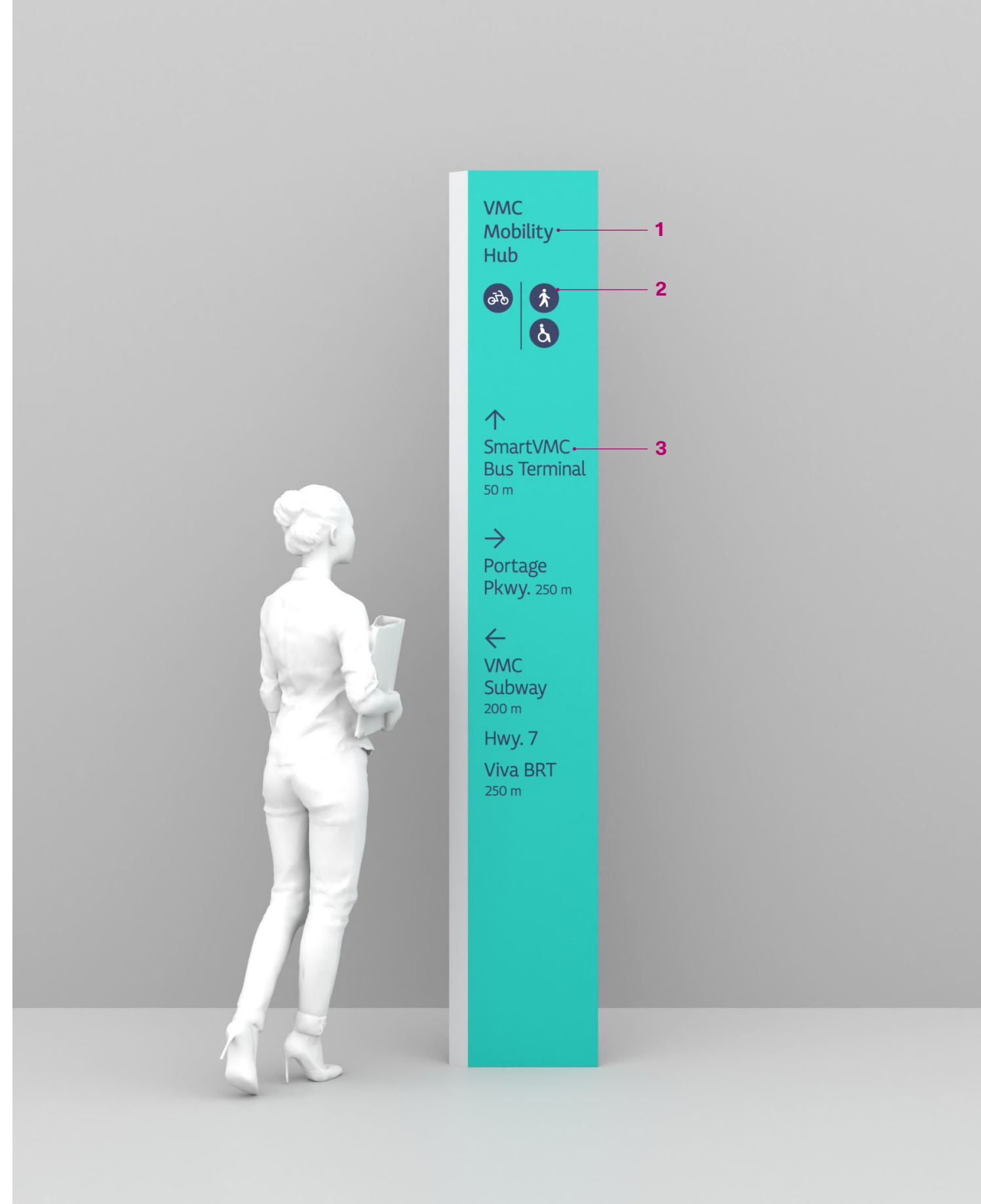

THE SIGN SYSTEM

T2: Bicyclist Directional, Curb-mounted

These signs are positioned along cycling facilities and are intended to provide directions to nearby parks and amenities, and assist in navigating along established cycling facilities.

Sign features:

- 1 Identification of the trail or area.
- 2 Identifies trail is for cyclists.
- 3 Simple directional information to nearby parks and major amenities with average walking times.

Typical locations:

Placed on the curbs adjacent to cycling facilities at traffic-controlled intersections where a cyclist may be stopped by a red light or stop sign. The T2 sign is preferred in more urbanized areas such as along the VMC's Urban Loop trail in order to reduce visual obstructions in high traffic areas.

Note: It is recommended for consistency that future development and landscaping within the VMC allow for an appropriate curb space along cycling facilities to integrate signs.

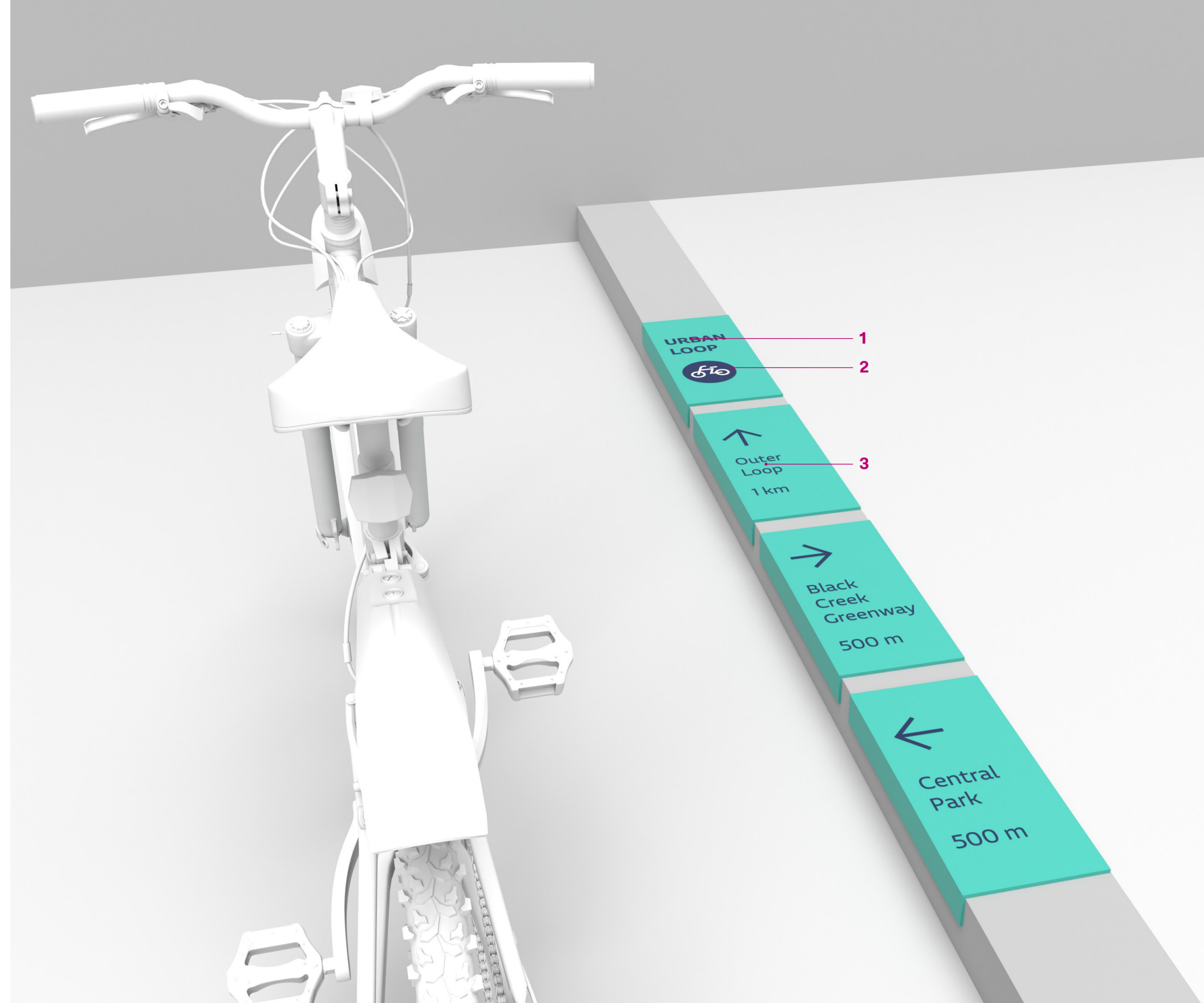

THE SIGN SYSTEM

VMC Map

Maps offer detailed contextual and visual information of a person's surroundings to orient them from where they are to where they plan to be, and are a key part of the VMC wayfinding system.

The system map displays the entire VMC area, and has been carefully designed to convey all information clearly and legibly. Colours are used in a way to optimize contrast and to complement City branding. Maps are always oriented north-up, and all text and pictograms are sized to maximize legibility while maintaining a clean, uncluttered appearance.

Map Features:

- 1 Road names for orientation.
- 2 Numbered overlays for key parks, greenspaces, public buildings, and services, and corresponding legend.
- 3 Identifies transit hubs with graphic illustrations.
- 4 "You are here" marker, scale bar, and north indicator.

Future Expansion of Map:

Additional maps may be developed if expanded beyond the VMC by following the established design intent. Where a different scale is deemed best, map elements and overlays should be reconsidered to optimize legibility and readability. Any new content should be considered and curated so as to not overwhelm the user. The following limits should act as a guideline for the map content thresholds.

- Limit numbered overlays to no more than 20.
- Limit graphic illustrations to no more than 8.

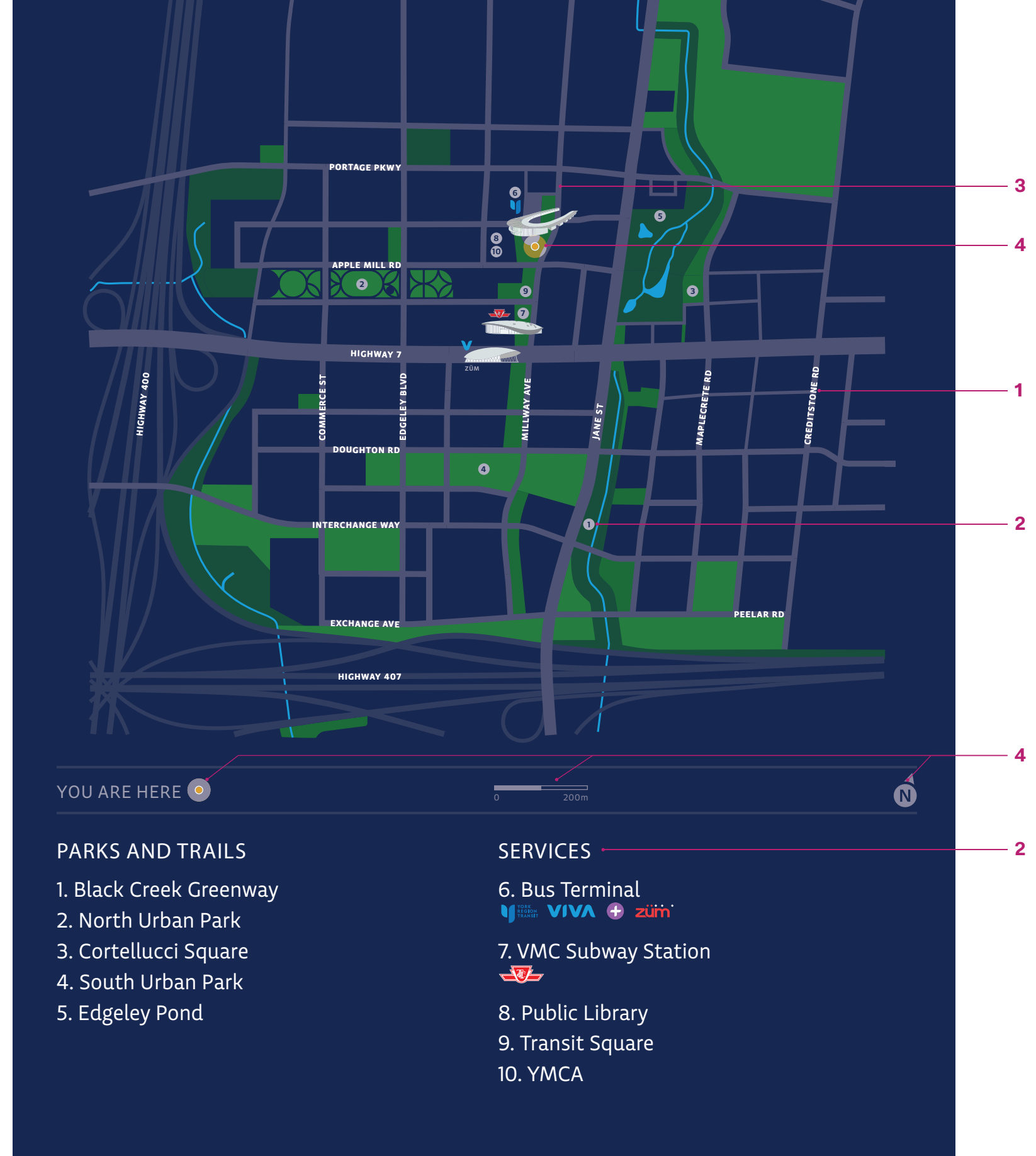

Sign Placement and Best Practice



SIGN PLACEMENT AND BEST PRACTICE

Guidelines and Considerations

The urban landscape is home to a host of conditions of various complexities making location planning exercises a delicate task. When planning the placement of signage elements, the following considerations should be thought through and discussed in order to find the most appropriate and effective locations.

Site Survey:

When considering a location, walk and experience the site itself to understand its surface conditions. Study how pedestrians are currently flowing through the area to help determine an appropriate location.

Sign Visibility:

The sign should be located where it will be visible to the public, as unobstructed from other elements of the streetscape as possible, and well lit after dark. Each location will have specific site conditions to consider, whether it's near a City building, park, trail, or along the streetscape.

Accessibility:

Each of the sign types has a minimum clearance radius that should be met whenever possible to support universal accessibility. The position of the sign should not disrupt the pedestrian clearway and should avoid becoming a physical obstruction to pedestrian flow.

Environmental Harmony:

Signs should feel natural and intuitive within their physical context. Location planning may also identify opportunities to remove, relocate, or replace nearby elements that are no longer necessary or out-of-date to ensure anything present is intended and harmonious.

Underground Obstructions:

Request reports from the proper authorities to determine if the location is hindered by any underground utility lines or their areas of easement. (e.g. hydro, sewage, data, etc).

Municipal or Private Property:

When a sign is best located on private property, ensure that there is an agreement in place with the owner of the property before finalizing the location. Ensure responsibilities for maintenance and upkeep are clearly delineated and agreed upon.

Special Considerations:

Determine if the location would be disruptive to any heritage building, landmark, piece of public art, or any other items of note.

Compliance:

Locations should adhere to any applicable City master plans, bylaws, building codes, and accessibility guidelines.



General Placement: Streetscape

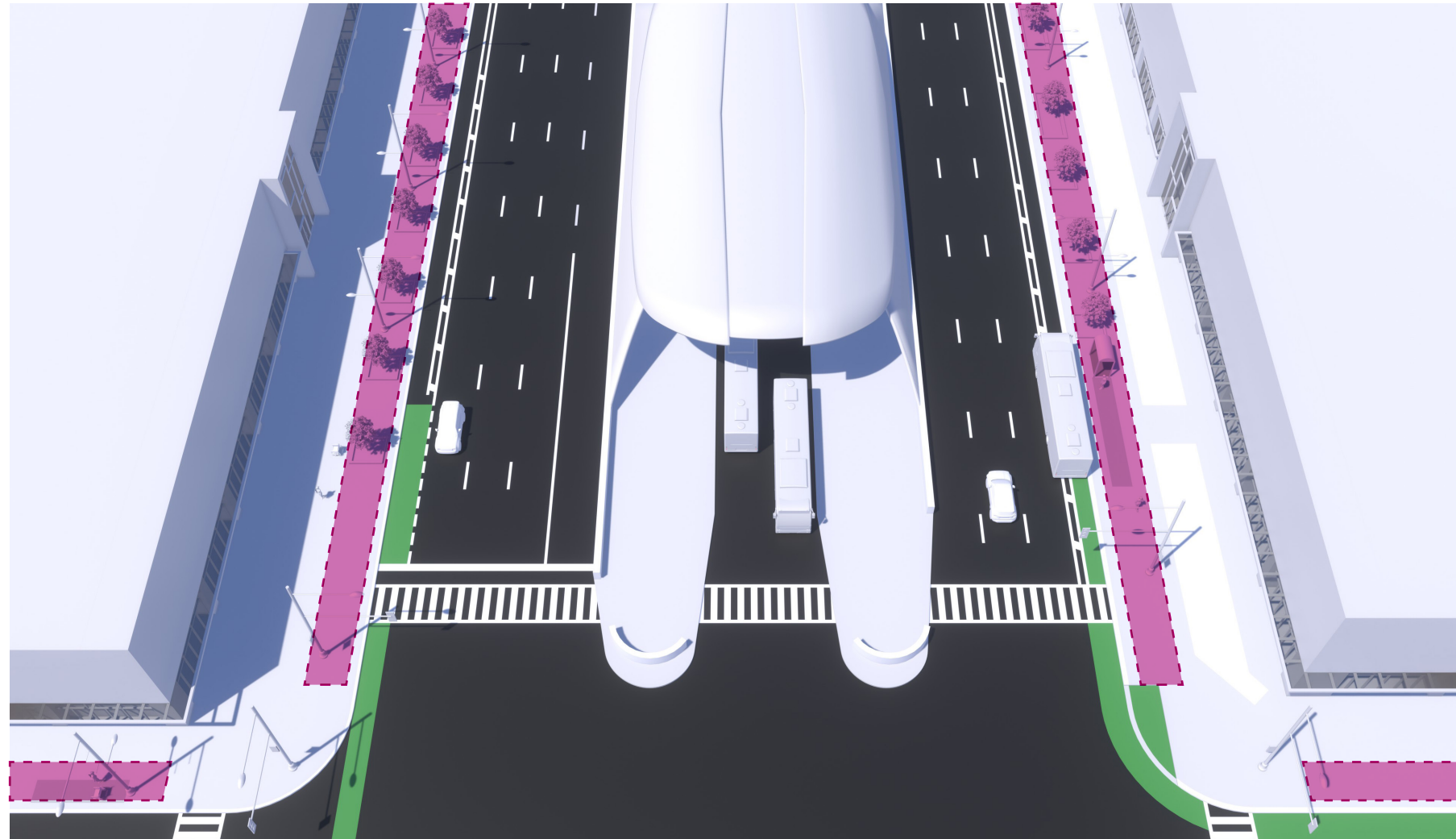

Amenity Zone Along Arterial Streets ↑

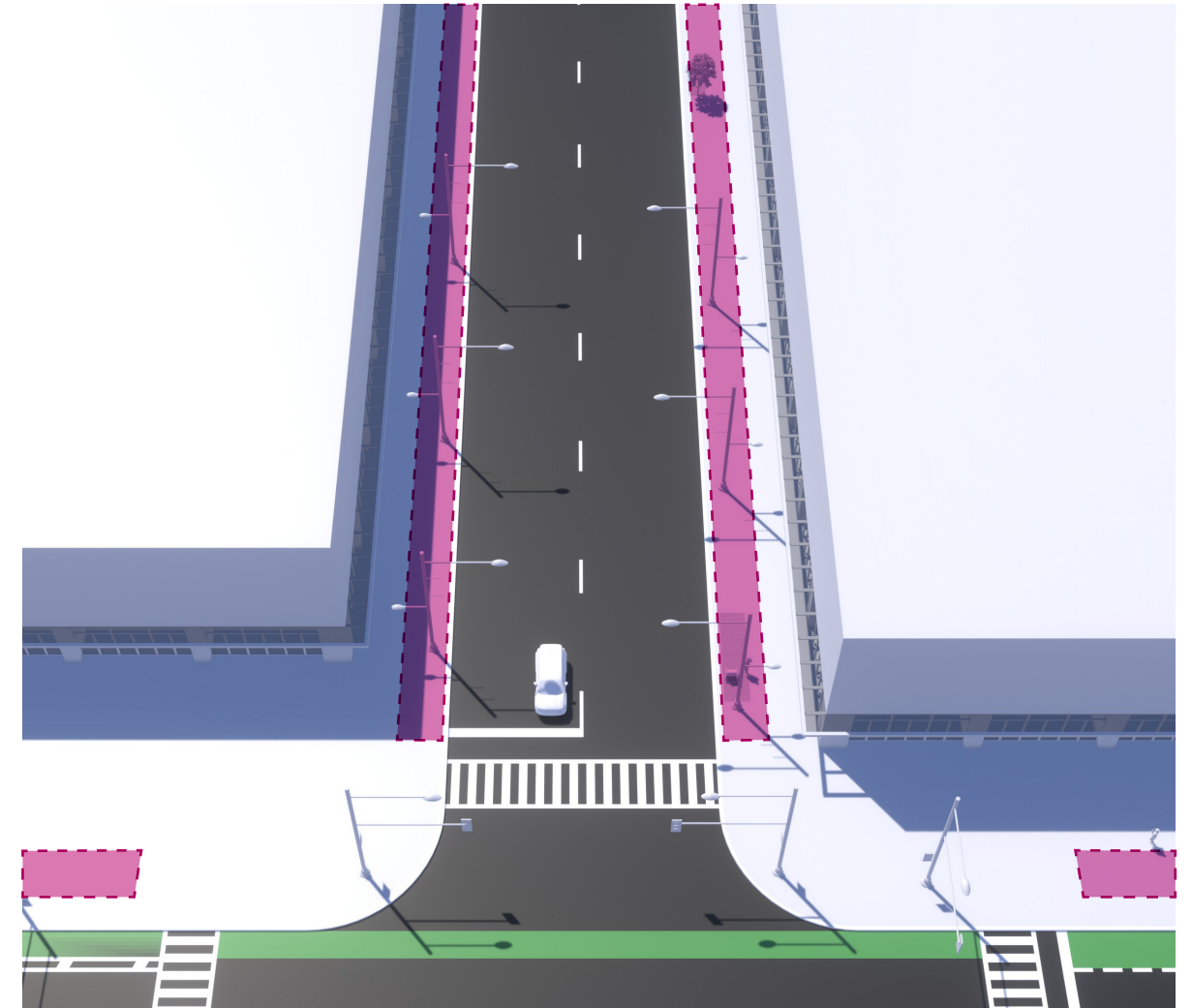

Amenity Zone Along Local Streets ↑

Streetscapes:

Typical city streetscapes, regardless of their size, can be broken down into distinct zones for vehicles, pedestrians, bicycles, amenities, or building frontage. Some of these zones may disappear as streets move from the largest arterial size down to the smallest local street or mews.

Wayfinding elements will generally be located in the amenity zone as close to the pedestrian clearway as possible provided the location remains within the City's

right-of-way, and the location is scrutinized for all other considerations outlined throughout this document (e.g. visibility, obstructions, codes, etc).

Where there isn't a clear amenity zone (e.g. narrower streets), wayfinding signage elements should be placed within the right-of-way area close to or within the pedestrian clear zone providing an uninterrupted width of at least 1525 mm is maintained to meet Vaughan Inclusive Design Standard

Legend

 Optimal location for signage.

General Placement: Streetscape

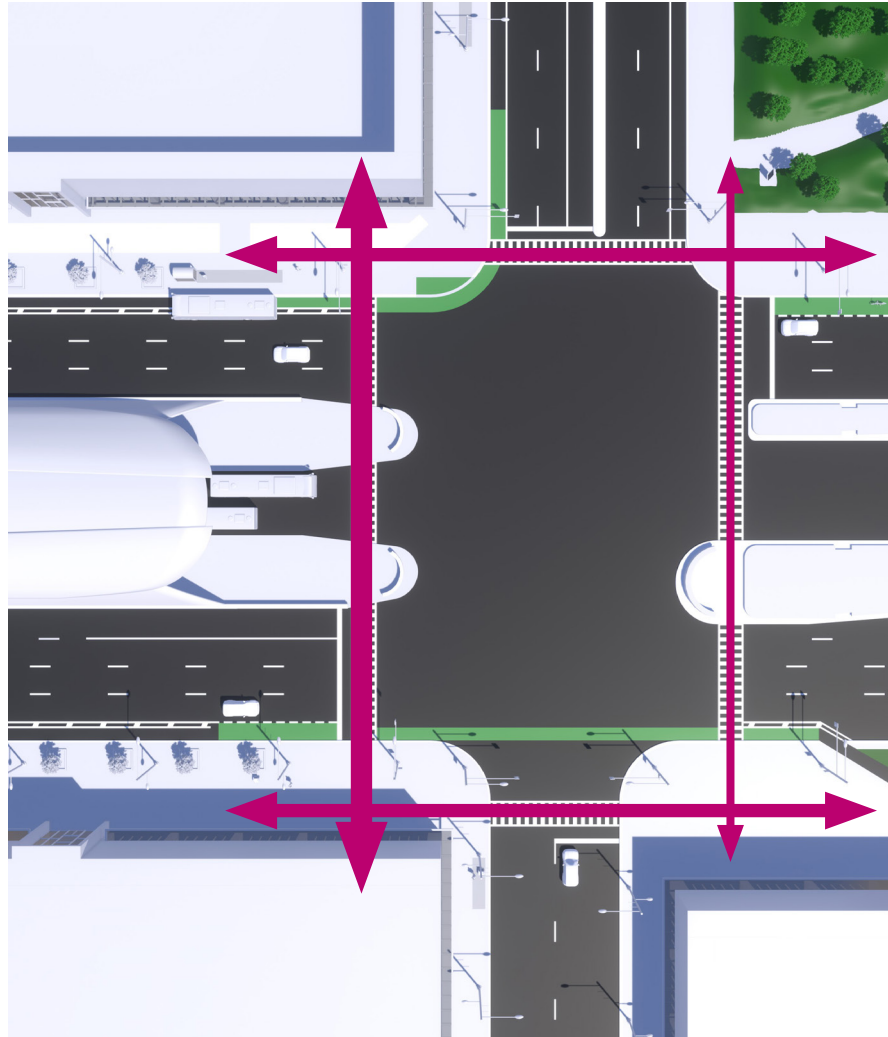

Example of Pedestrian Flow ↑

Traffic Flow:

Consider how pedestrians are moving through an area to help determine a good sign location. This will typically be where the pedestrian traffic flow is the heaviest and has the most potential for impact to the largest number of users. If there isn't a viable location in that area, consider where the second best option is, and so forth.

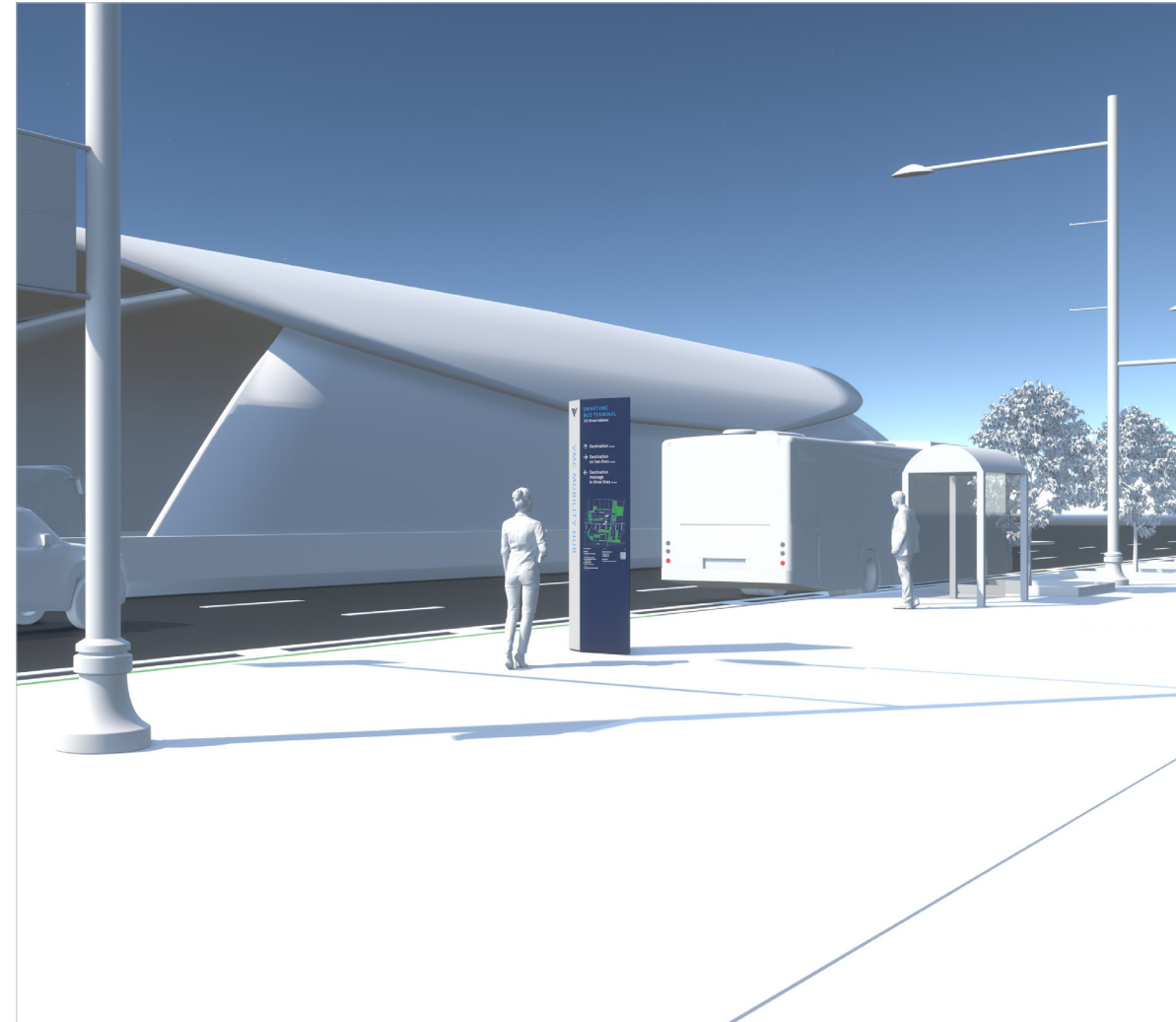

Proximity to Transit Hubs ↑

Visible & Intuitive Placement:

Signs are ideally placed where they will be visible from where they are needed, and located where it is intuitive and instinctive for users to look for it. This may be just outside a key public amenity like a transit station, at a major intersection, or near the entrance to a park or major greenspace.

Wherever signs are placed, it is important that they be visible from down the street or path pedestrians are traversing and, if possible, from across the street



Visibility from Opposite Corner of Intersection ↑

or intersection as well. Achieving this ensures any signage should be within a pedestrian's line of sight and offer them the wayfinding tools when they are needed.

General Placement: Lighting



Use Nearby Ambient Lighting ↑

Lighting:

Wherever possible, place signs within a few metres of nearby light sources such as light standards and lamp posts, or for wall-mounted signs, wall sconces. As the VMC wayfinding signs are not illuminated themselves, this will help keep the system reasonably visible and legible after dusk. This is especially important in the fall and winter when it becomes dark quite early.

Where there are no nearby light sources, consider the viability of adding one nearby. Well-lit areas also offer a semblance of safety, security, and a warm welcome.

Optimize Sign Frequency:

Oversigning can make an area seem cluttered and feel more complicated than it really is. Part of the location planning strategy is to optimize the total number of signs strictly needed—no more, no less. As the system is largely tethered to orienting residents and visitors, signs should be prioritized where these users are entering the VMC (e.g. region boundaries, transit hubs) with an additional sign or two near major parks, greenspaces, and any other communal hubs that the system highlights.

Ideally, there will be no more than one or two wayfinding signs in sight at any given time. Some exceptions may apply depending on the site conditions and overall complexity of an area. In these cases, additional signs may be required to help ease public navigation through the area in question.

General Placement: Alignment

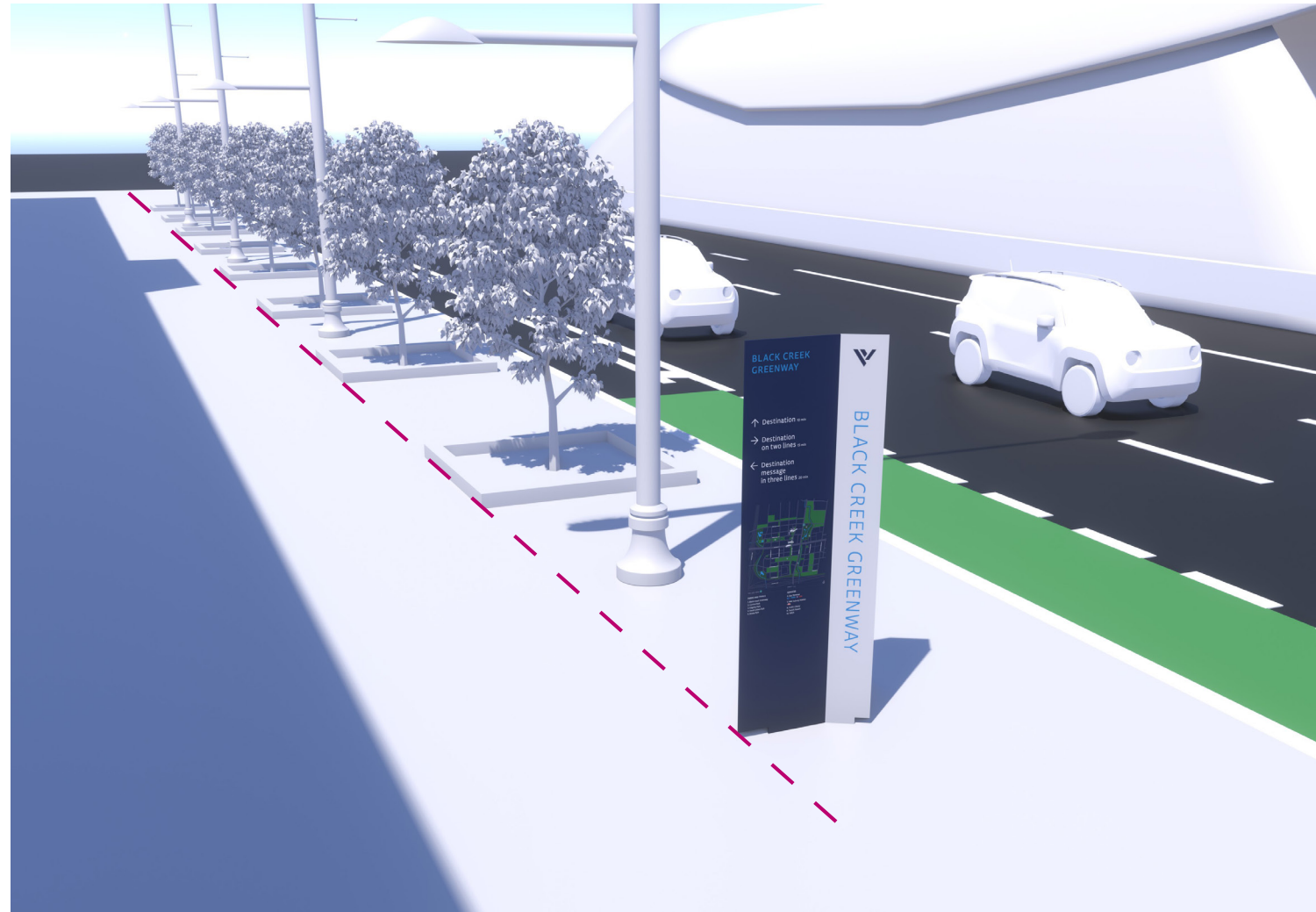

Alignment to Streetscape ↑

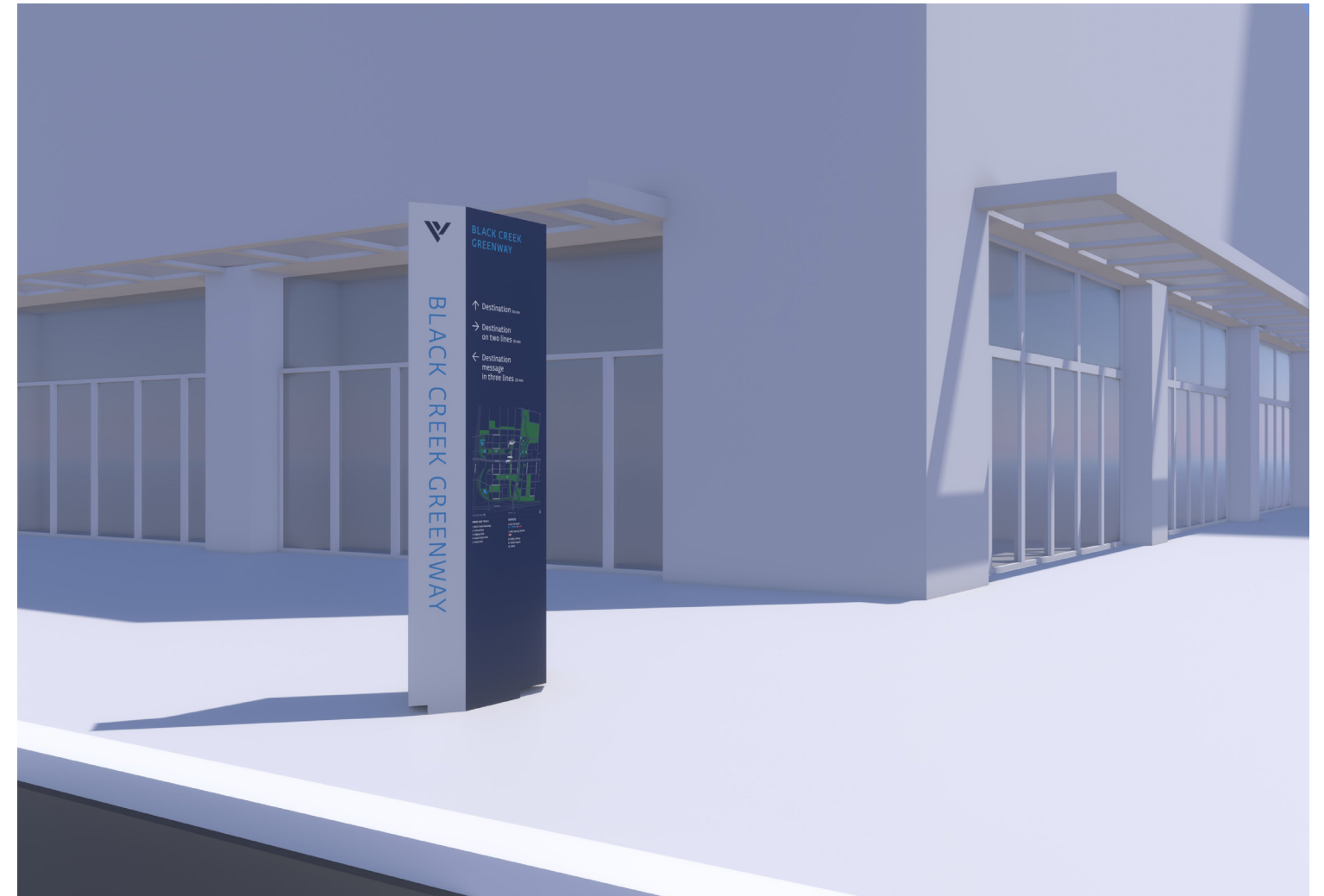

Alignment to Building Edge ↑

Aligning to the Environment:

Consider a designer’s view of the environment and think about where all nearby elements are placed, how they are aligned and juxtaposed to one another. Bear in mind the architecture of nearby buildings and structures. Think about the materials of the ground— is it all one material or is an area or section composed of another? This sort of analysis helps to determine places where signage can better integrate into the existing patterns and systems of an environment, and avoid them looking like an add-in or an afterthought.

Typical ways to integrate signs through this designer’s view analysis may include, and is not limited to:

- Aligning signs to building edges or corners.
- Aligning signs to the edge created by street furniture. This may be centre-aligned, or edge aligned.
- Aligning signs with architectural or structural features in the nearby environment.

Although aligning to the environment should be considered and achieved wherever it is viable and makes sense to do so, all other requirements such as sign visibility, accessibility, code compliance, etc, are more important to achieve.

General Placement: Parks and Greenspaces

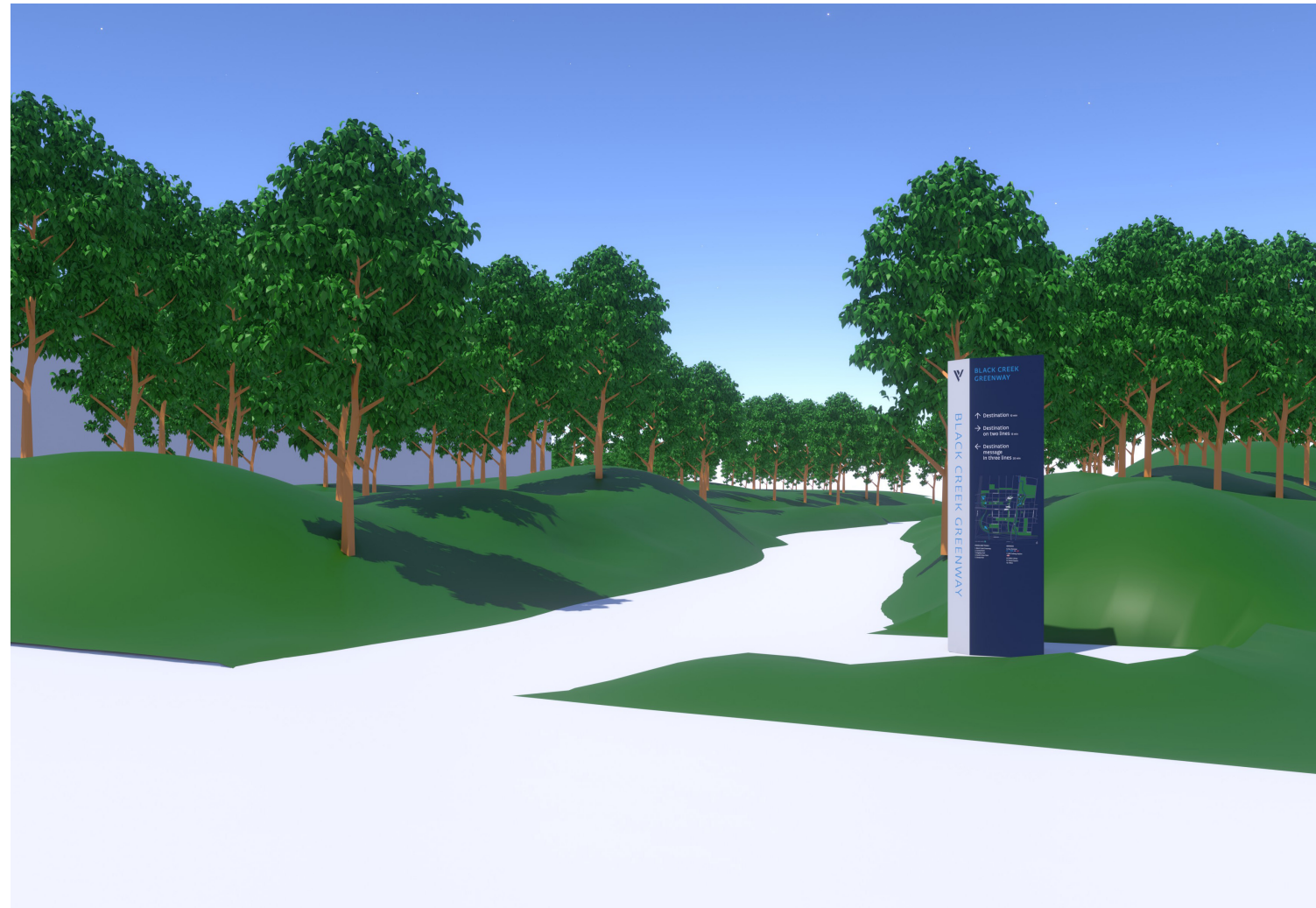

Location Just Within Park Bounds ↑

Encourage exploration:

Sign locations near parks and greenspaces should consider both natural entrances, as well as the formalized entry points from nearby streetscapes. Whenever possible, place signage within 5–10 metres of the perceived boundary of the park or greenspace. This helps to welcome and encourage pedestrians movement into these spaces all the while keeping the map, identification, and directional information available in a visible location.

Accessible:

As paths and trails within parks have limited space, most signs will be best placed to the side of a path. As turf is generally not accessible to those using mobility aids, detailed signs that may require a closer up view—such as the primary pylon—should have an accessible flat, paved surface to the sign. A clearance of 1525mm is required around all sides of the sign to ensure a pedestrian clear path that meets AODA and Vaughan Inclusive Design Standards.



Accessible Path to Sign ↑

Consider Landscape Design:

Larger parks and greenspaces often have landscaping elements at their point of entry whether it's gates, flowerbeds, or some other feature. At these locations, wayfinding signs should be integrated into landscaping plans so that all park/greenspace entrance elements work harmoniously together. Additionally, sufficient access to and around any wayfinding signs must be provided.

General Placement: Trails

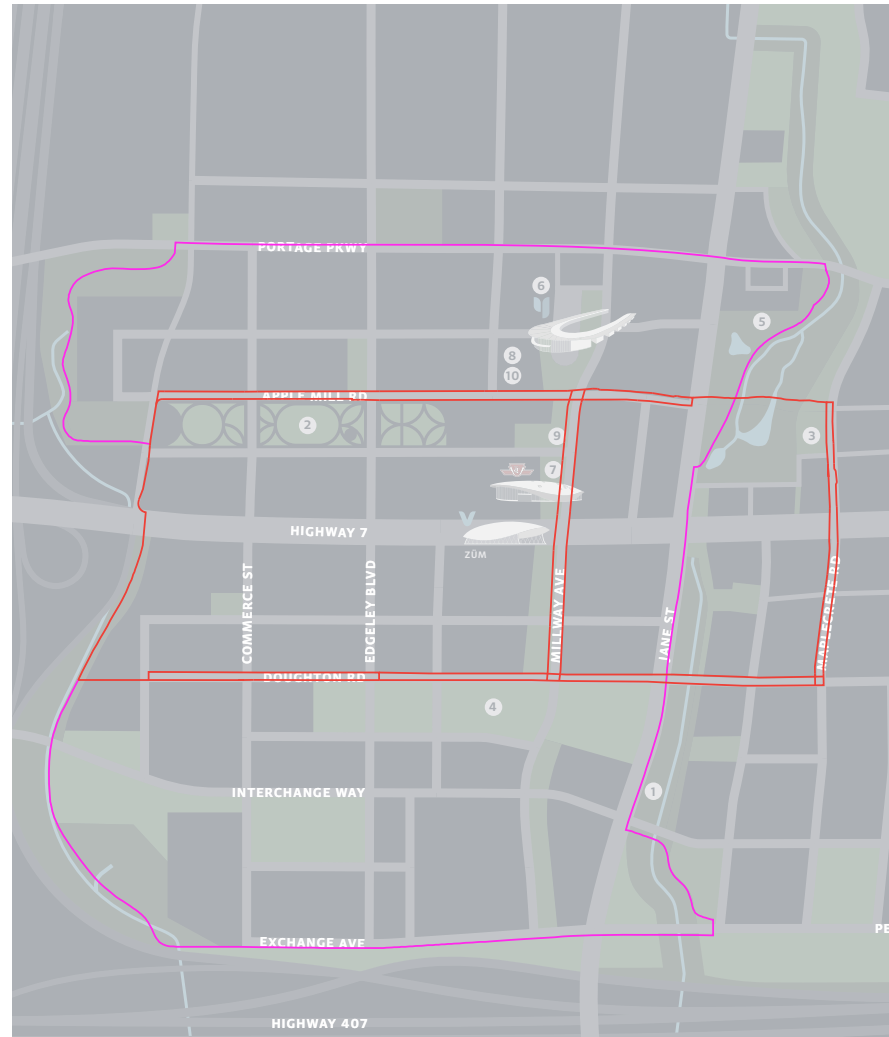

Urban Loop (red), Outer Loop (pink) ↑

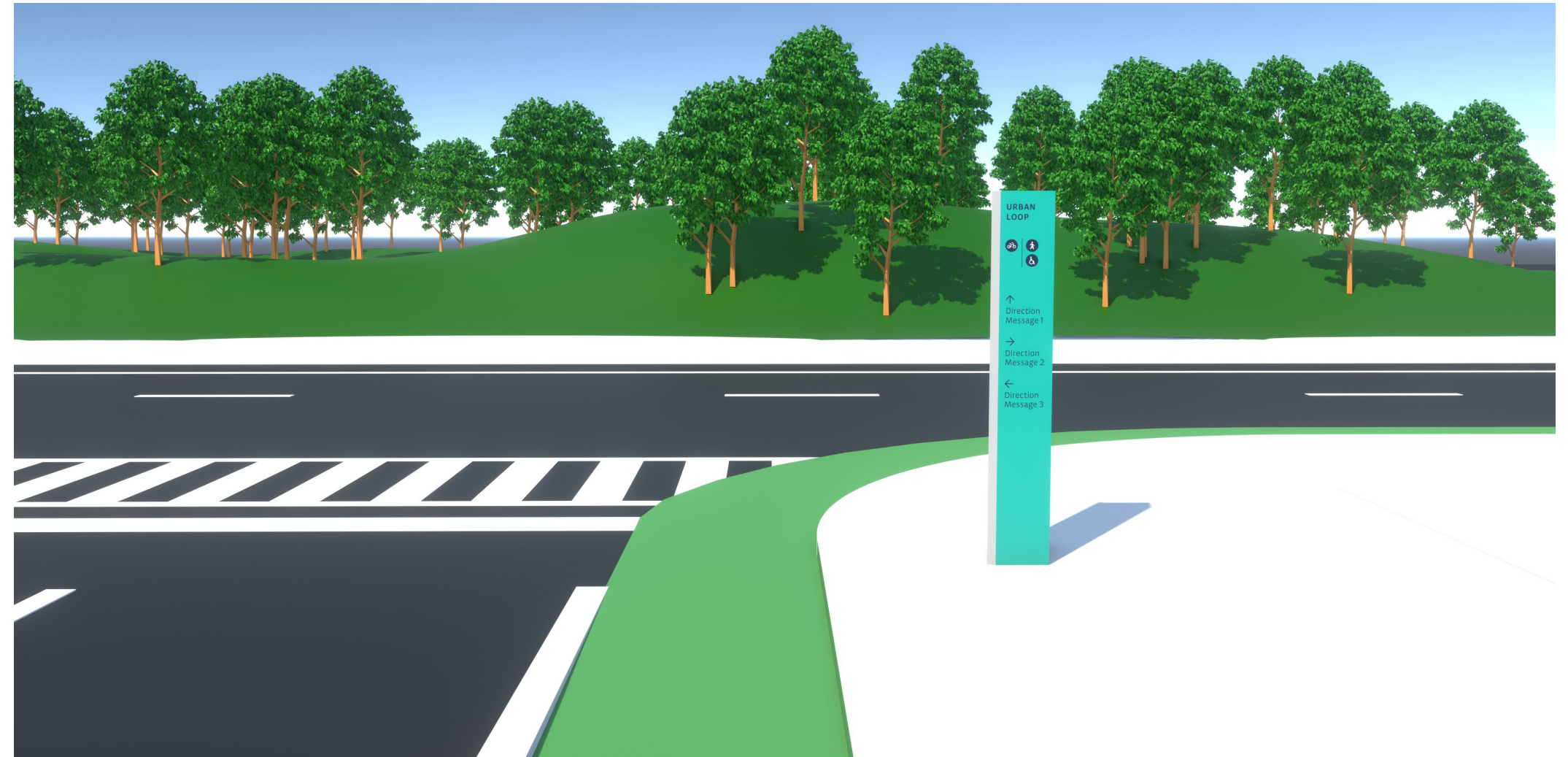

T1 Sign at Decision Point ↑

Trail Signs:

Two major trails for pedestrians and cyclists are planned for the VMC—the urban loop, and the outer loop. Both of these mixed-use trails follow vehicular roadways, and also enter into and out of the pedestrian path systems of parks and greenspaces.

Trail signs differ from other wayfinding elements in their ability to act as waymarkers to follow for pedestrians and cyclists looking to remain

on the path. These signs also offer directional information to nearby parks, greenspaces, and amenities located off of the path. Although trail signs also follow other sign considerations (visibility, code compliance, etc), the waymarker component is an added and necessary feature.

For an established trail to be successful, its users need to be made aware that they are navigating a set path, thus reducing the probability of veering

off it. This can be achieved by placing signs along the trail at decision points to act as waymarkers, as well as to provide additional directional information. This will typically be wherever the trail is disrupted by another trail or by a roadway.

Wherever possible, plan for a single sign when it can be used to help direct both pedestrian and cyclist traffic.

SIGN PLACEMENT AND BEST PRACTICE

Obstructions

The streetscape is a busy place and there are a lot of elements vying for ideal placement and public attention. In the hierarchy of things, a signage and wayfinding system should typically take precedence over most other furnishings. As the success of a wayfinding sign is directly linked to it being visible and accessible, it is recommended that other elements and obstructions be removed or relocated to accommodate them.

Items that can typically be relocated include, but are not limited to:

- Waste bins
- Benches
- Bicycle rings
- Poster columns
- Mailboxes
- Newspaper dispensers
- Parking pay stations

Items that cannot typically be relocated include:

- Trees
- Bus shelters, stops
- Light standards
- Underground structures

When an obstruction is immovable:

When the ideal location is not feasible, find the next best alternative placement that is as close as possible to the ideal location. The new location should still be visible from the intended decision point (e.g. intersection), be accessible to pedestrians, and comply with any other applicable considerations.

Where there is no good option and compromise is required, discuss the possibilities with affected parties and determine the best path forward.

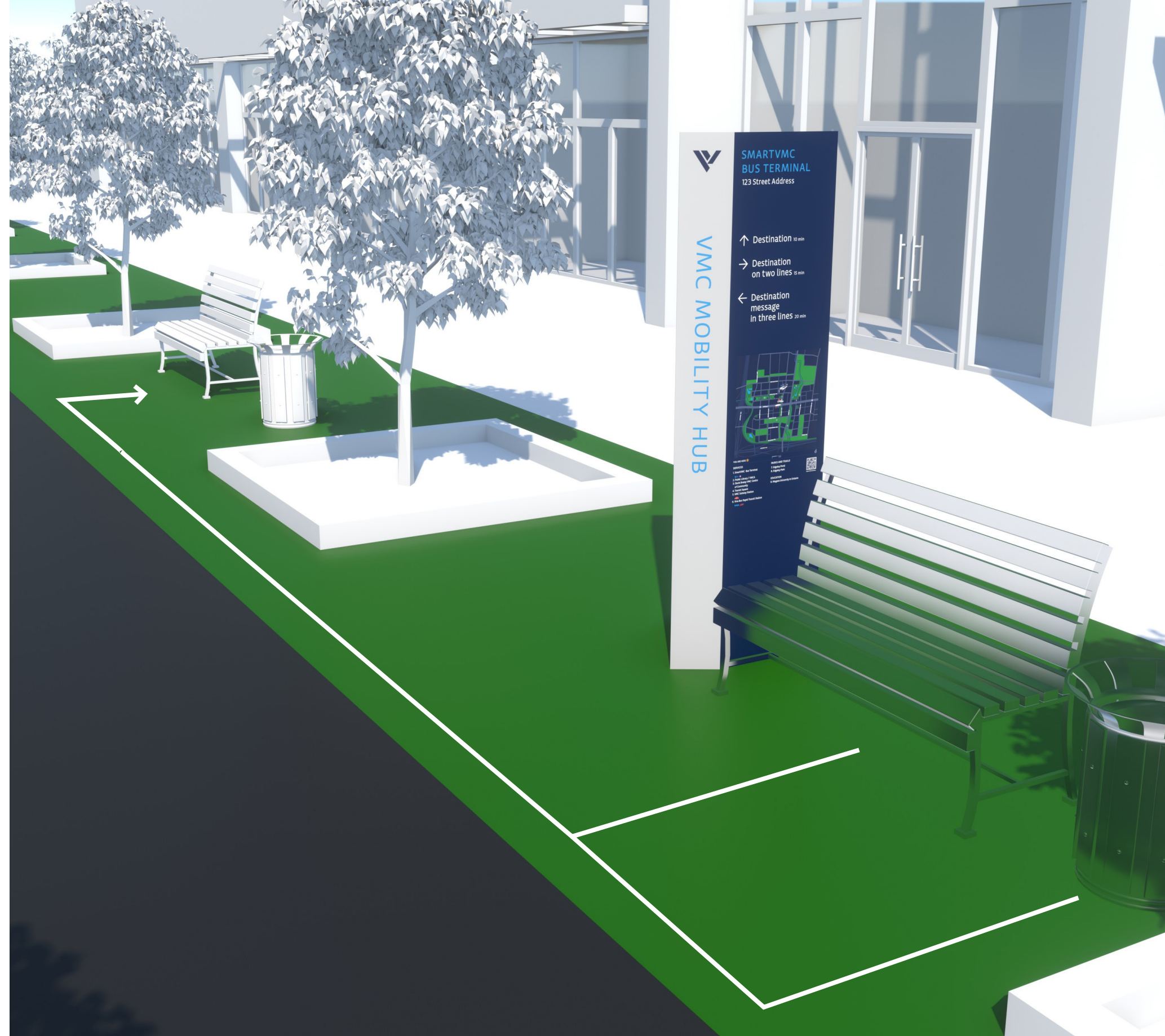

Example of Conflicting Placement with Site Furniture and Signage ↑

SIGN PLACEMENT AND BEST PRACTICE

Clearance

In order to ensure signage is visible and accessible, there are preferred margins of clearance from other streetscape elements and other obstructions.

STREETSCAPE ELEMENT	PREFERRED CLEARANCE (M)	MINIMUM CLEARANCE (M)
Curb – Arterial (large streets)	2	1.5
Curb – Collectors (medium streets)	1.5	1
Curb – Local Streets	1.5	1
Transit Shelters	10	5
Trees and Planters	3	2.5
Bicycle Rings/Rack	3	2.5
Waste Bins	3	2.5
Fire Hydrant or Service Connections	3	2
Light Standards / Unity Posts	3	2.5
Traffic signal poles and boxes	3	2.5
Parking Ticket/Pay-stations	3	2.5
Newspaper Dispensers	3	2.5
Transformers	4	4
Grating	3	1.5
All other streetscape elements	2	1.5

NOTE:

To meet AODA and Vaughan Inclusive Design Standards, signs require a clear floor area of at least 1525 mm in front of sign faces with content so that access from a front or side approach is possible for a person using a mobility device such as a wheelchair. Additionally, any sign placement cannot reduce the pedestrian clear path to a width less than 1525 mm.

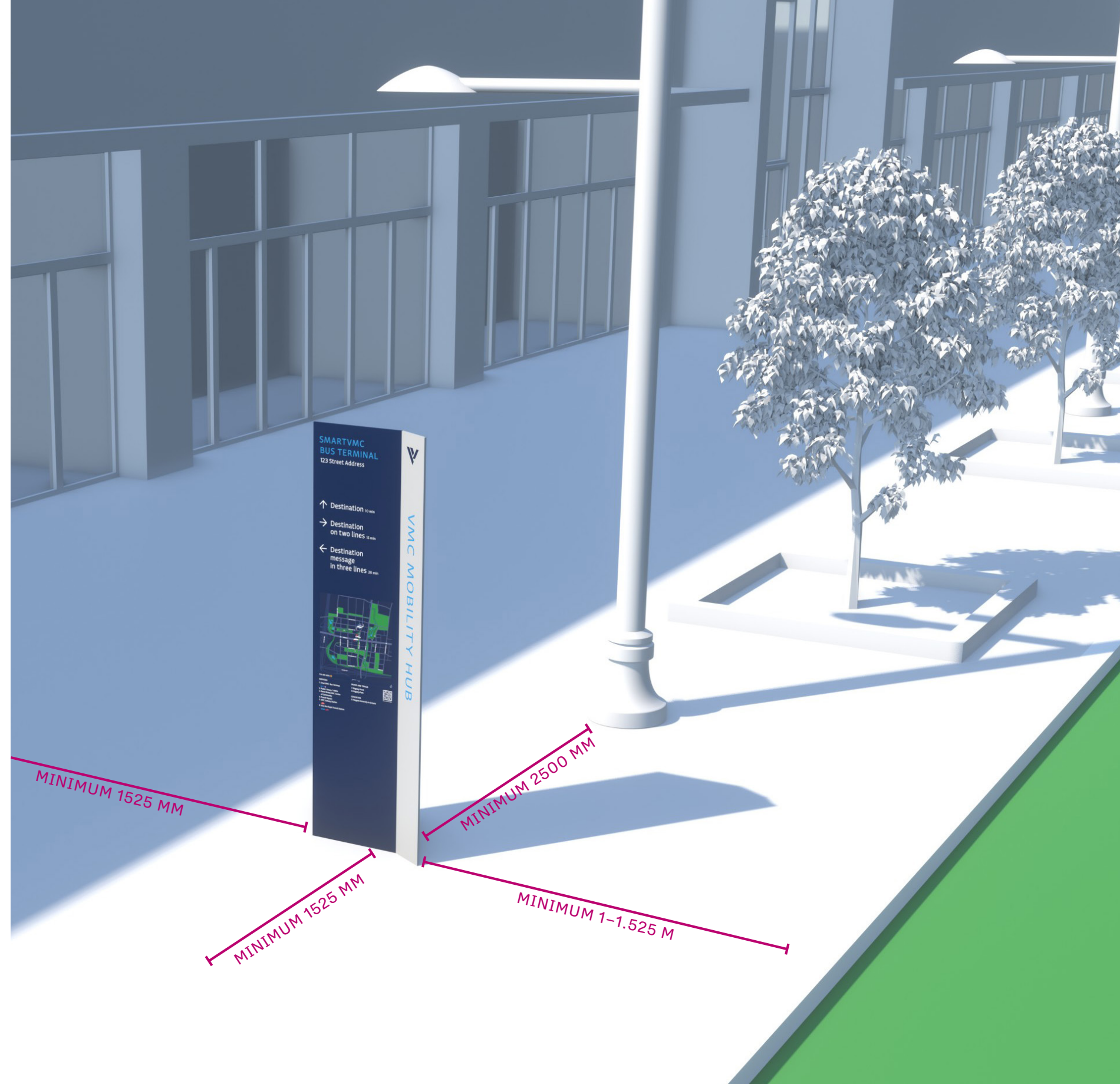

Example of Sign Clearance ↑

SIGN PLACEMENT AND BEST PRACTICE

Relevant Codes

There are a number of standards mandated by codes that are applicable to many of the wayfinding elements in this document. Included here is a selection of the most pertinent codes in terms of structure and placement that should be upheld and planned for. Depending on the conditions, additional codes may be applicable as well.

Should there be a conflict or other discrepancy between one or more codes, the most restrictive of them shall be met.

CITY OF VAUGHAN SIGN BYLAW

SECTION 17 – SIGNS PERMITTED ON PUBLIC LANDS WITHOUT SIGN PERMITS

Notwithstanding Sections 3.1 to 3.3, the following *Signs* shall be permitted on road allowances under the jurisdiction of *City*, in accordance with requirements specified herein and shall be exempted from the requirements of a permit.

17.1 PUBLIC INFORMATION SIGNS

Public Information Signs as permitted.

“Public Information Sign” means any *Signs*:

- a. Erected by or under the direction of a government agency;
- b. designating public hospitals, schools operated by a *Regional Municipality of York School Board* and the *Regional Municipality of York Separate School Board*, *Vaughan Public Libraries*, *Vaughan Community Centres*, *Vaughan Public Arenas* or other public government use; and/or
- c. required by the *City* to inform the public of proposed zoning changes, official plan amendments, severance, plans of subdivision on the property subject to the application;

6.5 GROUND SIGNS

The following regulations shall apply to all *Ground Signs*:

- a. *Ground Signs* shall be set back a minimum of 1.0 m from all street lines;
- b. No *Ground Sign* shall exceed 5.0 m in any dimensions of the *Sign Face*;
- c. No more than one (1) *Sign* shall be mounted to the supporting structure of any *Ground Sign*. Notwithstanding the foregoing, additions may be allowed to existing *Ground Signs* provided that additions are of the same design, material and shape as the existing *Sign*;
- d. No *Ground Sign* shall exceed a maximum height of 7.5 m from the finished grade level at the base of the supporting structure of the said *Sign*;
- e. *Ground Signs* shall be setback a minimum of 1.5 m from any common lot boundary with an adjacent lot;
- f. A *Ground Sign* including any part of its structure shall not be located closer than 1.0 m to any driveway;
- g. No *Ground Signs* shall be *Erected* where the distance between a structure and the street line is less than 4 m;
- h. One (1) *Projecting Sign* shall be permitted in-lieu of a *Ground Sign* where such distance is less than 4 m;
- i. Not less than 2.44 m clearance shall be provided to the underside of any part of a *Ground Sign* located above a walkway;

6.9 PROJECTING SIGNS

The following regulations shall apply to all *Projecting Signs*:

- a. No portion of a *Projecting Sign* shall be less than 2.44 m above the finished grade or floor level immediately below such *Sign*;
- b. No *Projecting Sign* shall exceed 1.0 square metres in area per *Sign Face*; and
- c. No *Projecting Sign* shall be illuminated internally.

The City Of Vaughan By-Law, By-Law Number 140-2018

AODA

Exterior paths of travel, technical requirements

80.23 When constructing new or redeveloping existing exterior paths of travel that they intend to maintain, obligated organizations, other than small organizations, shall ensure that new and redeveloped exterior paths of travel meet the following requirements:

1. The exterior path must have a minimum clear width of 1,500 mm, but this clear width can be reduced to 1,200 mm to serve as a turning space where the exterior path connects with a curb ramp

Accessibility For Ontarians With Disabilities Act, 2005, Ontario Regulation 413/12

Location Planning



LOCATION PLANNING

Pedestrian Flow

The majority of non-residents travelling through the VMC are anticipated to enter through the area's transit hubs and travel along the highlighted routes to the nearest parks and greenspaces. A1 signs have been prioritized to support navigation along these routes.

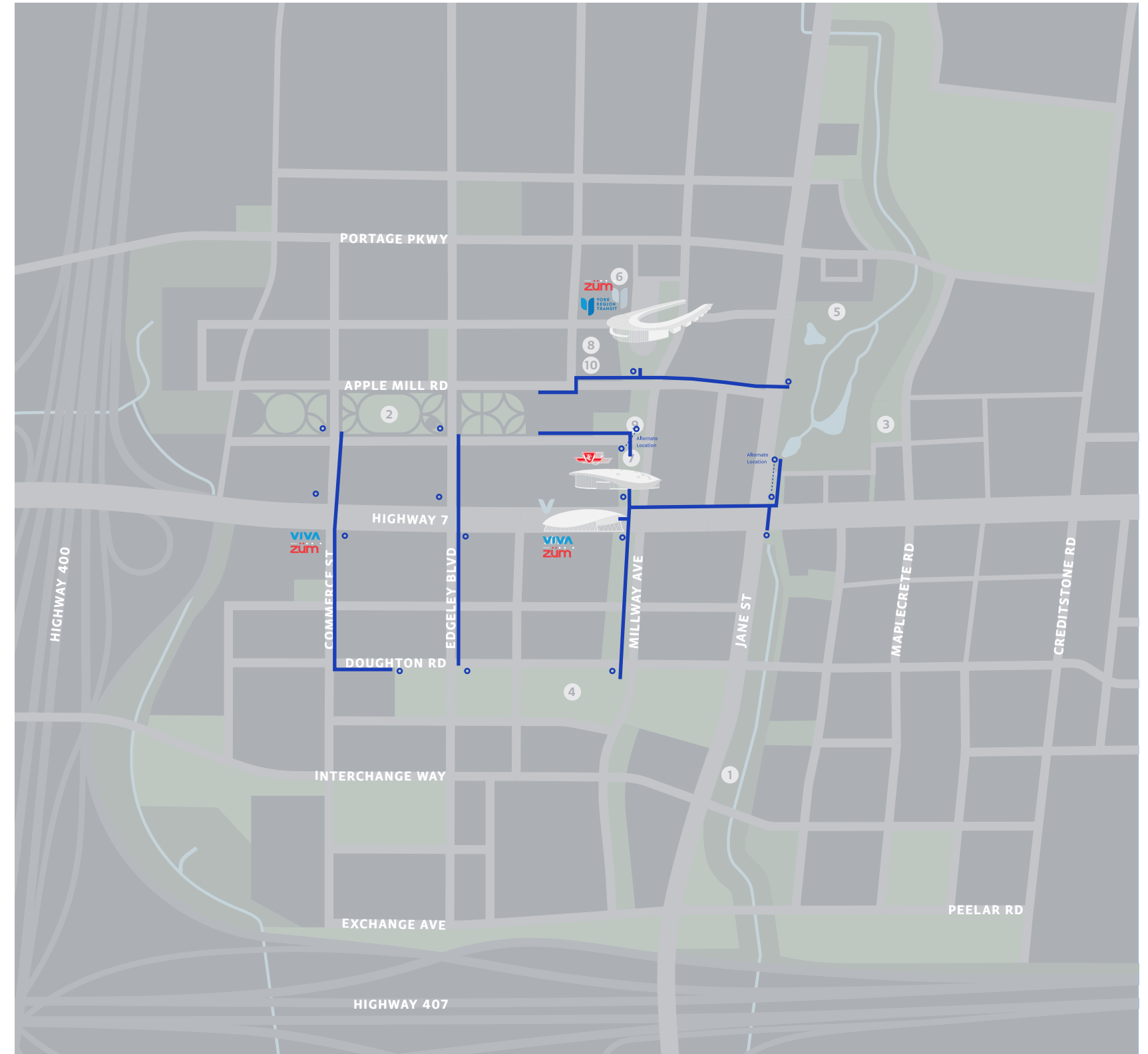

Sign locations are subject to change based on the latest issued Landscape plan drawing.

- Sign Type A1
- Pedestrian Flow

LOCATION PLANNING

Urban Loop

The future 'Urban Loop' will both circle and intersect the core of the VMC, and will add an additional layer of directional signage to be followed. Signs should be located only when there is a change of direction in the path, or when a path is disrupted by a road or another trail.

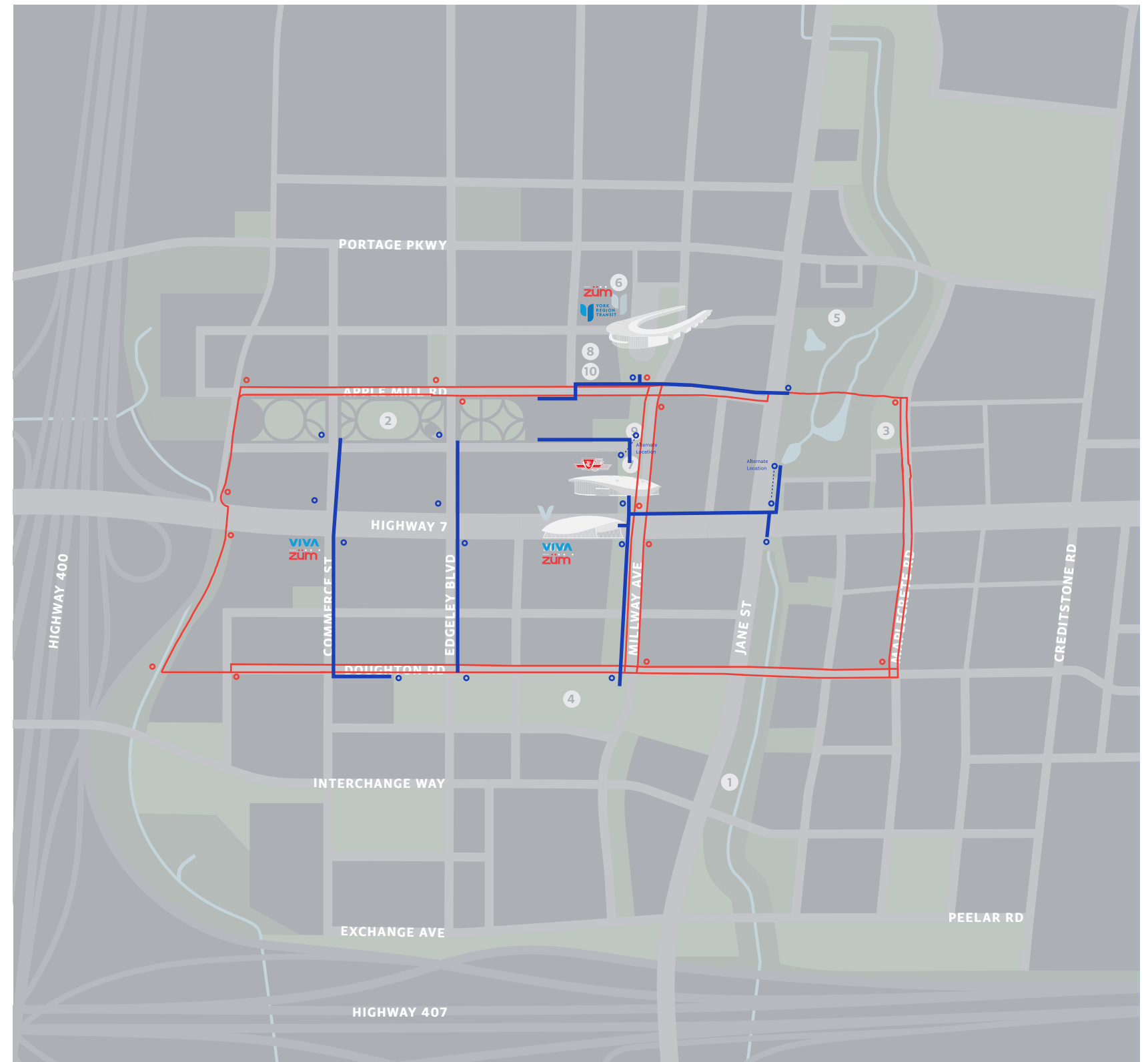

- Sign Type A1
- Sign Type T1/T2 (Urban Trail)
- Pedestrian Flow

Sign locations are subject to change based on the latest issued Landscape plan drawing.

LOCATION PLANNING

Outer Loop

Similarly, the future 'Outer Loop' will circle the outer edges of the VMC, and will add an additional layer of directional to be followed. Signs should be located when there is a change of direction in the path, or when a path is disrupted by a road or trail.

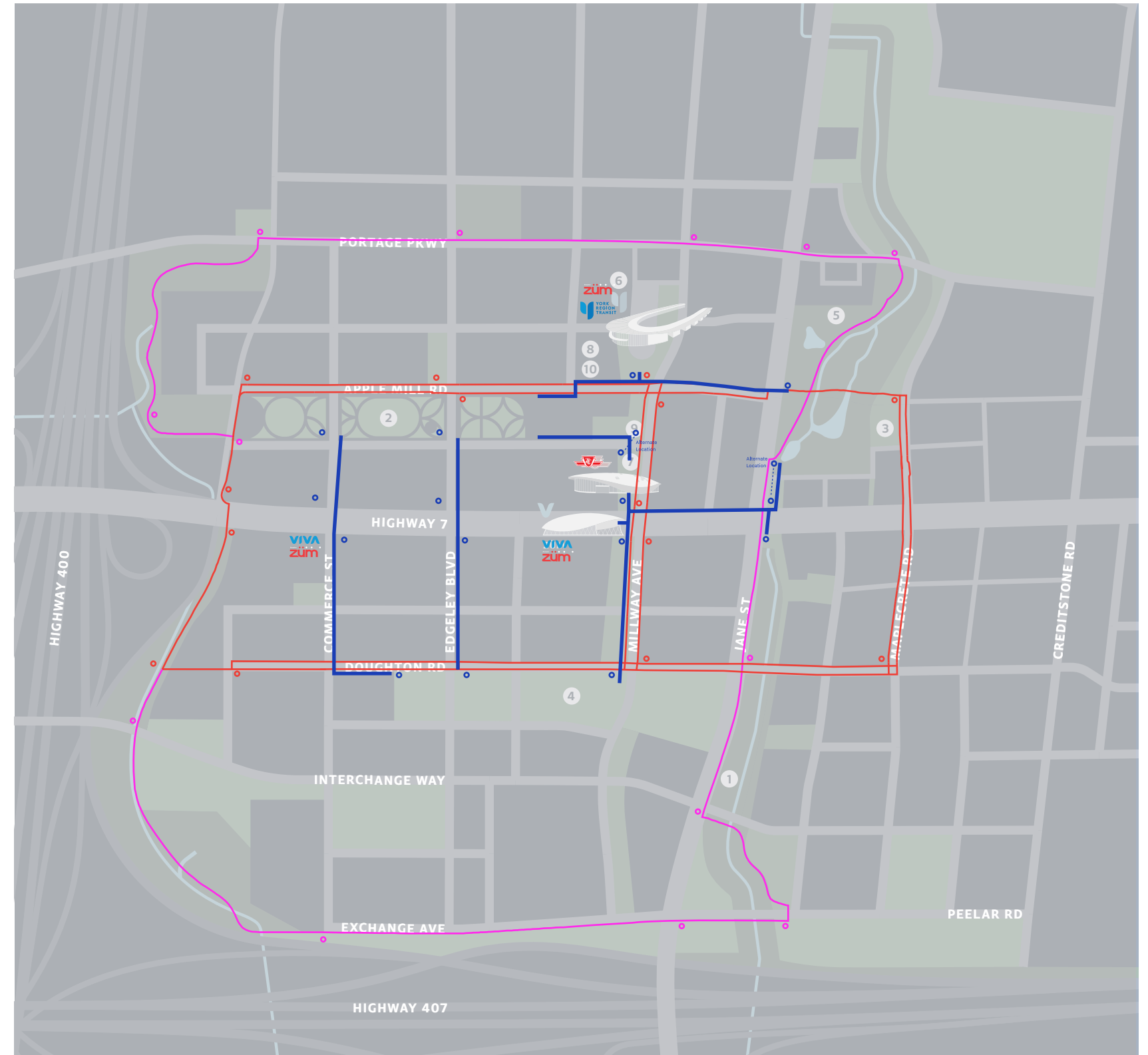

- Sign Type A1
- Sign Type T1/T2 (Urban Trail)
- Sign Type T1 (Outer Trail)
- Pedestrian Flow

Sign locations are subject to change based on the latest issued Landscape plan drawing.

LOCATION PLANNING

Additional Cycling Facilities

Additional facilities for bicycles are available along most roadways throughout the VMC. As many of these intersect with the Urban and Outer Loop trails, signs are encouraged at these points to direct trail users to their desired trails and destinations.

- Sign Type A1
- Sign Type T1/T2 (Urban Trail)
- Sign Type T1 (Outer Trail)
- On-road Cycling Facilities
- Pedestrian Flow

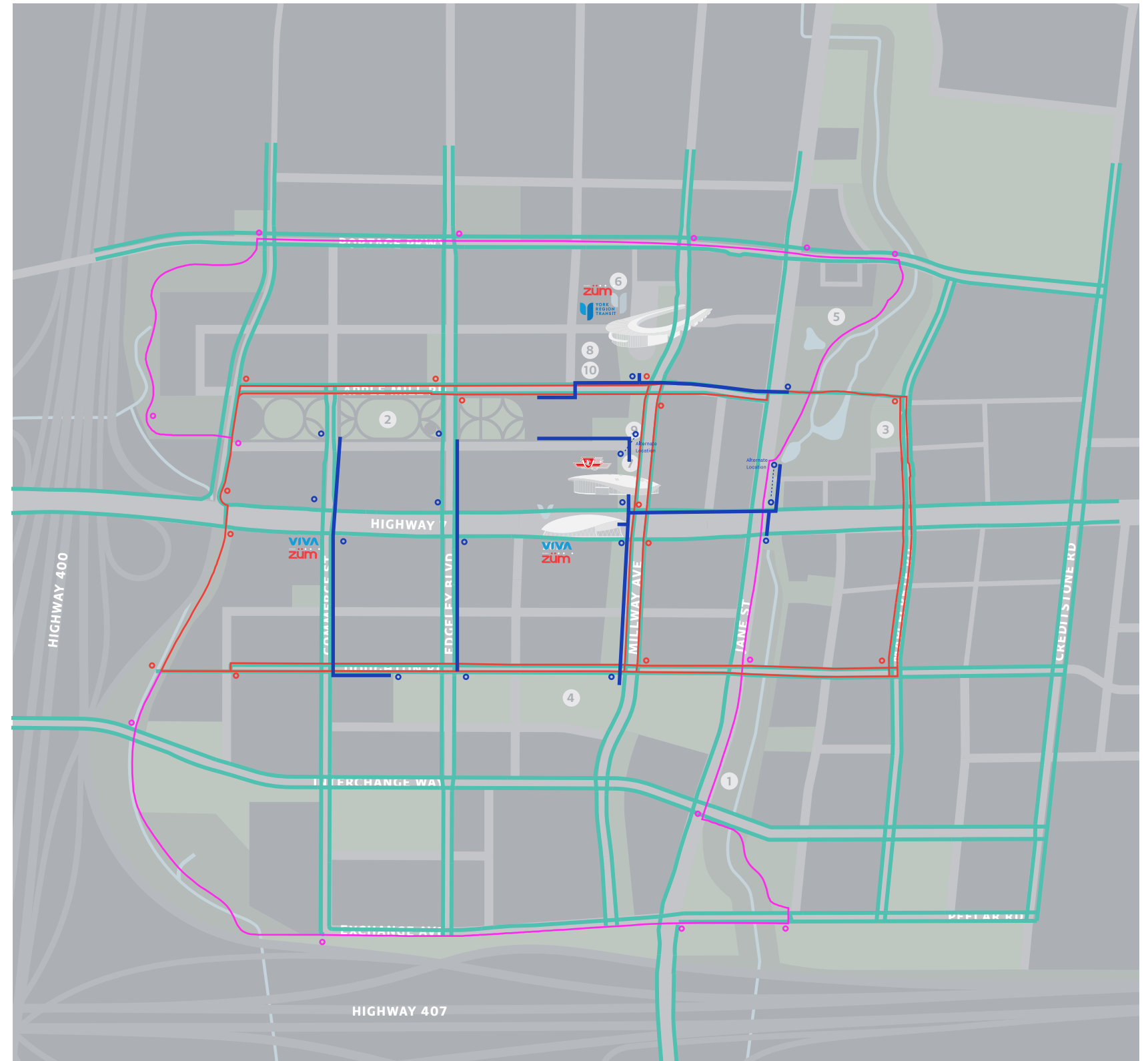

Sign locations are subject to change based on the latest issued Landscape plan drawing.

Preparing for Procurement and Implementation:



PLANNING FOR PROCUREMENT AND IMPLEMENTATION

Typical Procurement and Fabrication Schedule

While the VMC continues to develop, it is recommended to include the design, fabrication, and installation of wayfinding signage components in the Development Application Review and Construction process. This will be beneficial in ensuring signage is implemented in a timely manner, and also to ensure wayfinding signage is being coordinated with other involved disciplines and installation timelines. If this is not possible, a typical procurement process may be necessary.

Procurement

The following are the estimated timelines required for a typical procurement process as well as some evaluation criteria for consideration.

Schedule

- Prepare for procurement: 2 weeks
- Run procurement: 3 weeks
- Review & Reward: 2 weeks

Tender Criteria for Bidders:

- Pricing
Provided as unit costs for easy comparison.
- Relevant Experience
Show a minimum of three relevant projects done over the past five years. Provide shop drawing examples from previous projects of similar complexity.
- Past Performance
Provide at least three references from past projects.
- Schedule
Provide timeline of work to accommodate any deadlines.
- Subcontractors
Ensure any anticipated subcontractors are made known.

- Acknowledgment of Instructions
Document pages with special instructions, requests of samples and/or mock-ups, etc, to be signed by contractors to acknowledge they'll be followed.
- Interview with top applicants (optional)

Fabrication and Installation

Sign fabrication and installation are typically broken down into these phases of work. Actual times are to be confirmed by signage contractors in their bids/proposals.

Schedule

- Site Review: 2 weeks
- Shop Drawings: 3 weeks
- Samples: 2 weeks (concurrent with above)
- Engineering: 2-3 weeks
- Sign Permits: 2-8 weeks (where applicable)
- Fabrication: 10-12 weeks
- Installation: 2-3 weeks

Invoicing / Payment Schedule

Sign fabricators typically request the following:

- 25% — Initial project deposit
- 25% — After shop drawings, samples, permits approved
- 25% — After fabrication is completed
- 25% — After installation and deficiency review completed



PLANNING FOR PROCUREMENT AND IMPLEMENTATION

Sign and Maintenance Cost Estimates

The following is a list of system sign types and their estimated fabrication and installation costs. Anticipated quantities are based on the location plans in the previous section of this document.

Maintenance Considerations:

It is recommended that the governing group of the VMC wayfinding system additionally plan for sign inspections on a bi-annual or annual basis to ensure the accuracy of information and overall sign quality.

Future map and signage updates should be developed based on the review feedback from the pilot prototypes to ensure content is appropriate to local perceptions. Similar updates may be required when it comes to message thresholds on signage and to optimize the expected lifespan for each sign type.

Although the weather should wash away most dirt and grime, some will build-up over time. The City should plan for occasional wash and wipe-downs of signs to keep them appearing fresh and approachable. Where signs have been located near vegetation, foliage should be trimmed regularly to ensure any shrubbery or branches are not obstructing visibility or access to any wayfinding signage.

Refer to the Appendix for specification and maintenance on powdered coated signage from the VMC Pilot Project.

Sign Type	Cost Estimates	Est. Qty	Total Cost (VMC)
A1: Primary Pylon	\$15,500 - \$18,000	16	\$263,500 - \$306,000
ID1: Destination ID, Wall-Mounted	\$4,500 - \$6,500	10	\$45,000 - \$65,000
ID2: Destination ID, Freestanding	\$10,000 - \$12,500	20	\$200,000 - \$250,000
ID3 : Destination Freestanding	\$9,500 - \$12,000	10	\$95,000 - \$120,000
T1 : Trail Directional, Freestanding	\$14,500 - \$17,000	32	\$464,000 - \$544,000
T2: Bicycle Directional, Curb-mount	\$9,000 - \$11,000	6	\$54,000 - \$66,000

Total: **95** **\$1,121,500 - \$1,351,000**

Note:

- Costs are estimations. Actual costs are to be quoted by signage contractors during procurement. Estimates include materials, foundations, installation, and labour.
- Quantities subject to change as VMC planning continues to develop.

Appendix: Graphic Assets and Technical Details



Graphic Assets: VMC Branding

Preferred Logo for Signage

The existing VMC logo includes smaller qualifying text 'downtown' and 'metropolitan centre' which become difficult to read when the logo is sized for use on the signage pylons. The descriptors are not essential to expressing the brand, and can seem out-of-place when the signage is located in parks, paths, and natural open spaces. As such, a simplified logo should be used on signage for simplicity, recognizability and cross-region relevance.

EXISTING VMC LOGO











LOGOS FOR SIGNAGE

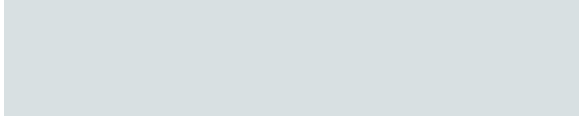

GRAPHIC ASSETS AND TECHNICAL DETAILS

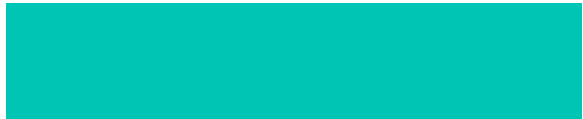
Graphic Assets: Colours

				
NAME	Navy	Blue	Light Grey	White
PANTONE	655C (Map - 85%, 65%,25%)	2925C	7541c	
CMYK	100 92 41 45	71 27 00 00	14 7 8 0	0 0 0 0
EXTERIOR PAINT	MP14112 Blue Polo		MP02972 Slightly Blue	
OPAQUE VINYL				
REFLECTIVE VINYL				
APPLICATION	Main sign panel colour for A1, ID1, ID2, ID3 Primary text colour for T1 and T2	Destination text colour for A1	All sign panel's fin and support structure for ID2 and ID3	All white coloured text and graphics on all sign

				
NAME	Aqua	Greenspace Green	Park green	Secondary Park Green
PANTONE	3265c	555c	7732c	7739c
CMYK	64 00 38 00	84 28 98 15	83 28 98 15	81 15 100 2
EXTERIOR PAINT				
OPAQUE VINYL				
REFLECTIVE VINYL				
APPLICATION	Main sign panel colour for T1 and T2	Map greenspace colour	Map park colour	Map secondary park colour

GRAPHIC ASSETS AND TECHNICAL DETAILS

Graphic Assets: Typography and Pictograms

Typography

The Echo Pro typeface has been selected for use in all sign types and maps. It complements the VMC sub-brand, and upholds to AODA and CSA standards in terms of accessibility and legibility.

ECHO PRO REGULAR

ABCDEFGHIJKLMNOPQRSTUVWXYZ
abcdefghijklmnopqrstuvwxyz 0123456789

ECHO PRO SEMIBOLD

ABCDEFGHIJKLMNOPQRSTUVWXYZ
abcdefghijklmnopqrstuvwxyz 0123456789

Note:

Text should always have the following settings: kerning set to 'optical', tracking set to '0', and ligatures turned off. Any additional typographical considerations will be noted separately within each sign types graphic standards page.

Pictograms

These symbols have been selected with international standards and local considerations in mind so as to be widely recognizable. Additional pictograms matching the style may be integrated as future needs are identified.



GRAPHIC ASSETS AND TECHNICAL DETAILS

A1: Technical Details

Sign Type: A1.1

(Powder coat only)

Sign Panel:

13mm thick aluminum panel pylon. All visible surfaces to be graphic print sublimated in powder coat. Possible suppliers include:

- Alto (altoaluminum.com)
- Direct Embed Coating (directembedcoating.com)
- Decora (decorapowdercoatings.com)

Angled aluminum panel to be welded to larger panel- weld and grind smooth-two part epoxy with powder coat to extend below grade.

Colour:

Navy to match Pantone 655c

Blue to match Pantone 3005c

Light Grey to match Pantone 7541c

Text/Graphics:

All text and graphic to be digitally applied powder coated.

Sign post, Foundation:

Mount sign structure onto finished concrete foundation.

Notes: General Artwork for face panel to be provided post award.

See the following technical detail pages for the interior structure and additional details.

Sign Type: A1.2

(With Vinyl Graphics)

Sign Panel:

13mm thick aluminum panel pylon with painted finish to match respected colours (Matthews Paint):

- Alto (altoaluminum.com)
- Direct Embed Coating (directembedcoating.com)
- Decora (decorapowdercoatings.com)

Angled aluminum panel to be welded to larger panel- weld and grind smooth-two part epoxy with powder coat to extend below grade

Colour:

Navy to match Pantone 655c

Blue to match Pantone 3005c

Light Grey to match Pantone 7541c

Text/Graphics:

All text and graphic to be cut vinyl. Map to be digitally printed on clear vinyl applied on first surface.

Sign post, Foundation:

Mount sign structure onto finished concrete foundation.

Notes: General Artwork for face panel to be provided post award.

See the following technical detail pages for the interior structure and additional details.

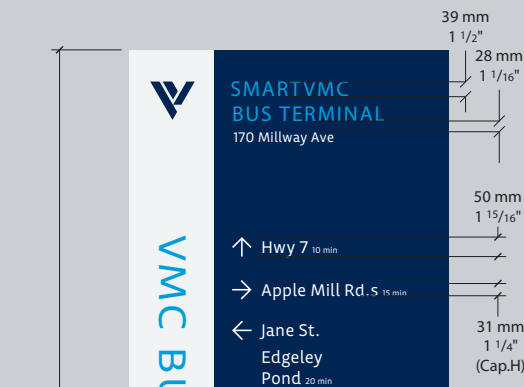
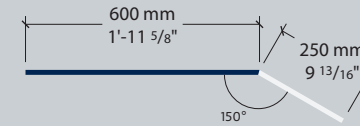
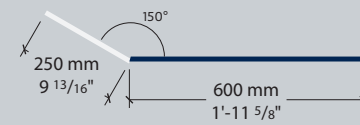

Front

Back



A1: Technical Details



Phone: 905.660.7310
 Toll Free: 1.888.236.4703
 Fax: 905.660.0777
 info@spectra-signs.com

3-299 Basaltic Road
 Concord, ON
 L4K 4W8

SIGN TYPE: A1

Primary Pylon, Freestanding

PROJECT NUMBER: 220479

REVIEWED BY:

2121 ARGENTIA ROAD, 4TH FLOOR
 MISSISSAUGA, ONTARIO, L5N 2X4
 EXPERT@RIMKUS.COM
 (800) 580-3228 | (905) 607-7244

W/N: 100190298 DATE: 06/01/2023

DESIGN LOADS AS PER ONTARIO BUILDING CODE 2012 AS AMENDED BY RESOLUTION 88/19 FOR VAUGHAN, ON
 S_s = 1.1 kPa
 S_r = 0.4 kPa
 q 1/50 = 0.44 kPa
 SPECIFIED WIND LOAD = 0.911 kPa
 FOR SIGN ID3 - INTERIOR INSTALLATION - NO LATERAL LOAD

STEEL
 HSS - F_y = 350 MPa
 STEEL PLATES - F_y = 300 MPa
 ANCHOR BOLTS - A307 MIN.
 REINFORCING STEEL - F_y = 400 MPa

ALUMINUM
 MIN. F_y = 240 MPa

CONCRETE
 F_c = 25 MPa

SOIL
 γ = 19.0 kN/m³
 C_u = 30 kPa

DRAWINGS REVIEWED FOR SIGN STRUCTURAL MEMBERS AND CONCRETE DESIGN AND CONNECTION DESIGN ONLY.



NOTE:
 DURING CONSTRUCTION DO NOT DISTURB THE SOIL ADJACENT THE GRADE BEAM,
 /OR COMPACT THE SOIL AROUND THE GRADE BEAM FOR IT TO BE EFFECTIVE.

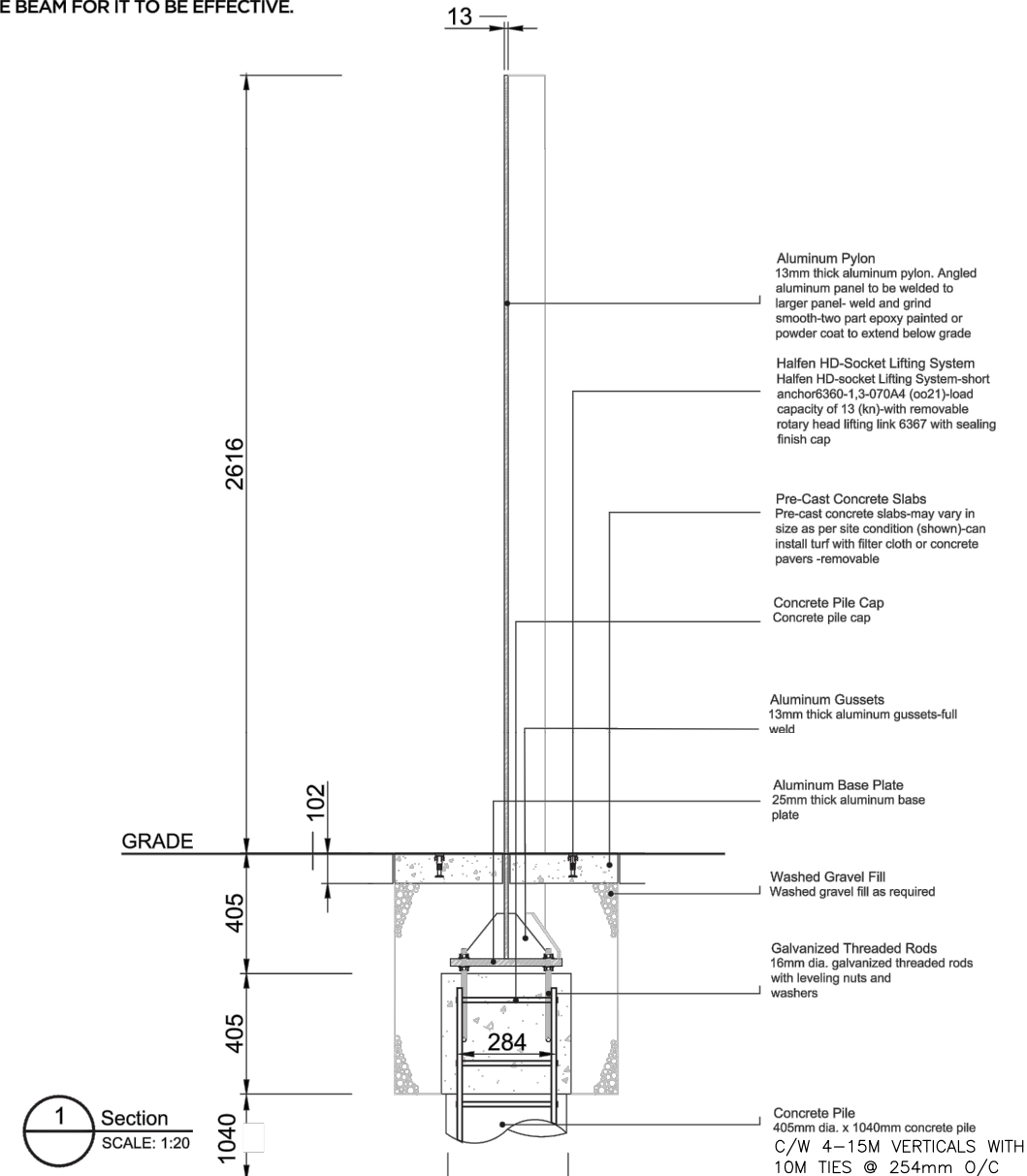
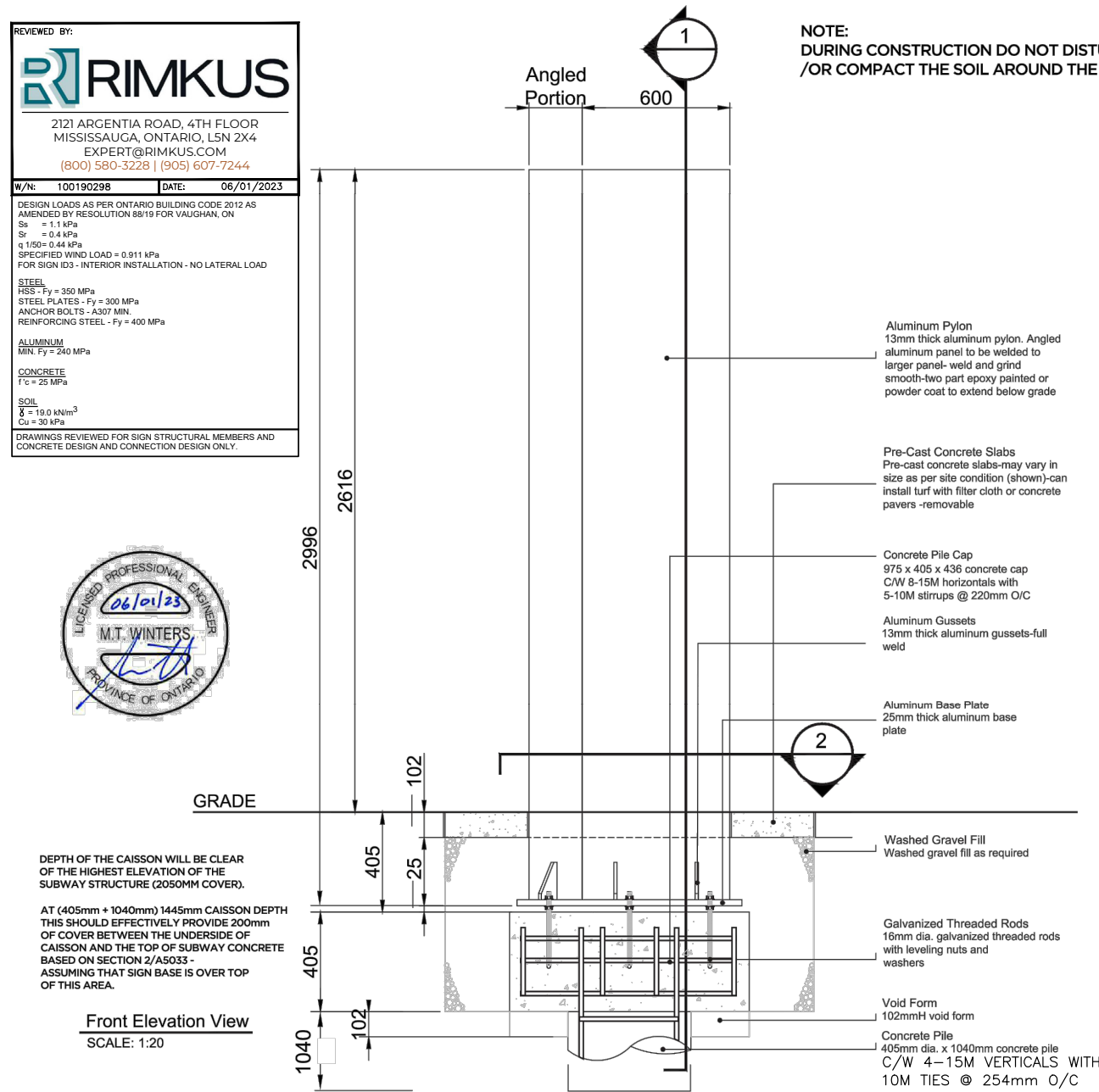

CLIENT
 Vaughan Metropolitan Centre

LOCATION
 3150 Hwy 7 | Vaughan, ON L4K 4R6

DESIGNER
 J.W.

PLEASE READ THE DISCLAIMER BELOW BEFORE APPROVING YOUR ARTWORK
 DESIGN NOTICE: WHEN PROVIDED A PROOF, IT IS THE CLIENT'S RESPONSIBILITY TO DOUBLE-CHECK AND THOROUGHLY PROOF-READ THE FOLLOWING: SPELLING, GRAMMAR, PUNCTUATION, ADDRESSES, PHONE NUMBERS, COLOUR, MATERIAL, SIZE & QUANTITY. ERRORS WILL BE FIXED AT NO ADDITIONAL CHARGE BUT CHANGES TO THE ORIGINAL DESIGN WILL BE CHARGED AT THE QUOTED HOURLY RATE. ANY ADDITIONAL COSTS INCURRED TO FIX ERRORS AFTER PRODUCTION ARE THE SOLE RESPONSIBILITY OF THE CLIENT.

GRAPHIC ASSETS AND TECHNICAL DETAILS

A1: Technical Details



Phone: 905.660.7310
 Toll Free: 1.888.236.4703
 Fax: 905.660.0777
 info@spectra-signs.com
 3-299 Basaltic Road
 Concord, ON
 L4K 4W8

SIGN TYPE: A1

Primary Pylon, Freestanding

PROJECT NUMBER: 220479

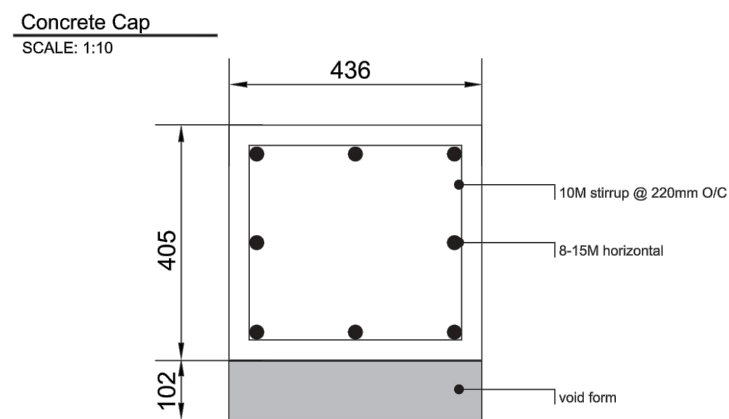
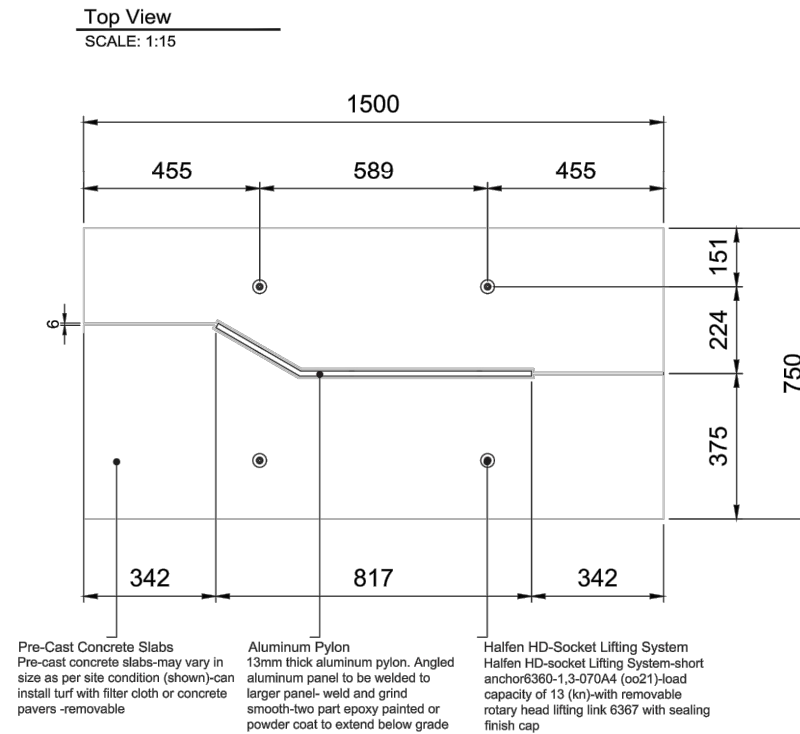
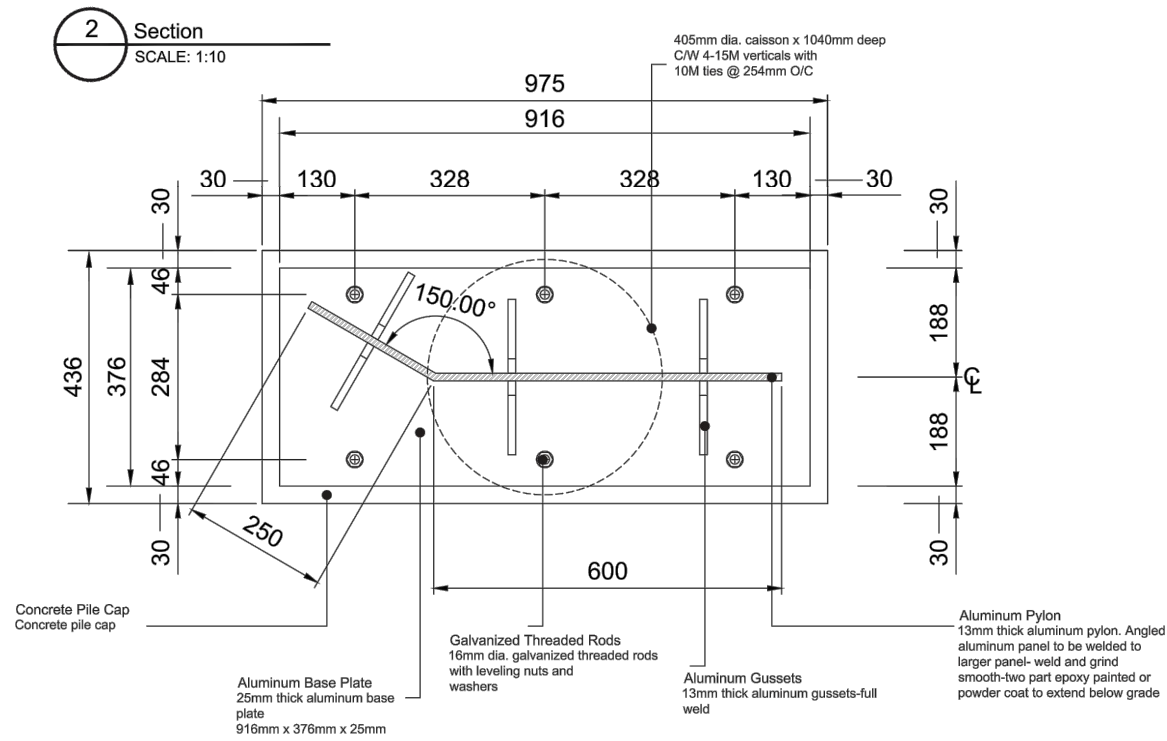

REVIEWED BY:

2121 ARGENTIA ROAD, 4TH FLOOR
 MISSISSAUGA, ONTARIO, L5N 2X4
 EXPERT@RIMKUS.COM
 (800) 580-3228 | (905) 607-7244

W/N: 100190298 DATE: 06/01/2023

DESIGN LOADS AS PER ONTARIO BUILDING CODE 2012 AS AMENDED BY RESOLUTION 88/19 FOR VAUGHAN, ON
S _s = 1.1 kPa
S _r = 0.4 kPa
q _{1/50} = 0.44 kPa
SPECIFIED WIND LOAD = 0.911 kPa
FOR SIGN ID3 - INTERIOR INSTALLATION - NO LATERAL LOAD
STEEL
HSS - F _y = 350 MPa
STEEL PLATES - F _y = 300 MPa
ANCHOR BOLTS - A307 MIN.
REINFORCING STEEL - F _y = 400 MPa
ALUMINUM
MIN. F _y = 240 MPa
CONCRETE
f'c = 25 MPa
SOIL
γ = 19.0 kN/m ³
Cu = 30 kPa
DRAWINGS REVIEWED FOR SIGN STRUCTURAL MEMBERS AND CONCRETE DESIGN AND CONNECTION DESIGN ONLY.

CLIENT
Vaughan Metropolitan Centre

LOCATION
3150 Hwy 7 | Vaughan, ON L4K 4R6

DESIGNER
J.W.

PLEASE READ THE DISCLAIMER BELOW BEFORE APPROVING YOUR ARTWORK
 DESIGN NOTICE: WHEN PROVIDED A PROOF, IT IS THE CLIENT'S RESPONSIBILITY TO DOUBLE-CHECK AND THOROUGHLY PROOF-READ THE FOLLOWING: SPELLING, GRAMMAR, PUNCTUATION, ADDRESSES, PHONE NUMBERS, COLOUR, MATERIAL, SIZE & QUANTITY. ERRORS WILL BE FIXED AT NO ADDITIONAL CHARGE BUT CHANGES TO THE ORIGINAL DESIGN WILL BE CHARGED AT THE QUOTED HOURLY RATE. ANY ADDITIONAL COSTS INCURRED TO FIX ERRORS AFTER PRODUCTION ARE THE SOLE RESPONSIBILITY OF THE CLIENT.

GRAPHIC ASSETS AND TECHNICAL DETAILS

ID1: Technical Details

Sign Type: ID1

(Powder coat only)

Sign Panels:

13mm thick aluminum panel. All visible surfaces to be graphic print sublimated in powder coat. Possible suppliers include:

- Alto (altoaluminum.com)
- Direct Embed Coating (directembedcoating.com)
- Decora (decorapowdercoatings.com)

Visible surface and edges to be powder-coated to match Navy. With lower angle bar to match Light Grey.

Colour:

Navy to match Pantone 655c

Blue to match Pantone 3005c

Light Grey to match Pantone 7541c

Text/Graphics:

All text and graphic to be digitally applied powder coated.

Sign post, Foundation:

Mount sign on existing wall.
Fabricator to determine appropriate hardware based on material and site condition of wall.

Notes: General Artwork for face panel to be provided by VMC.

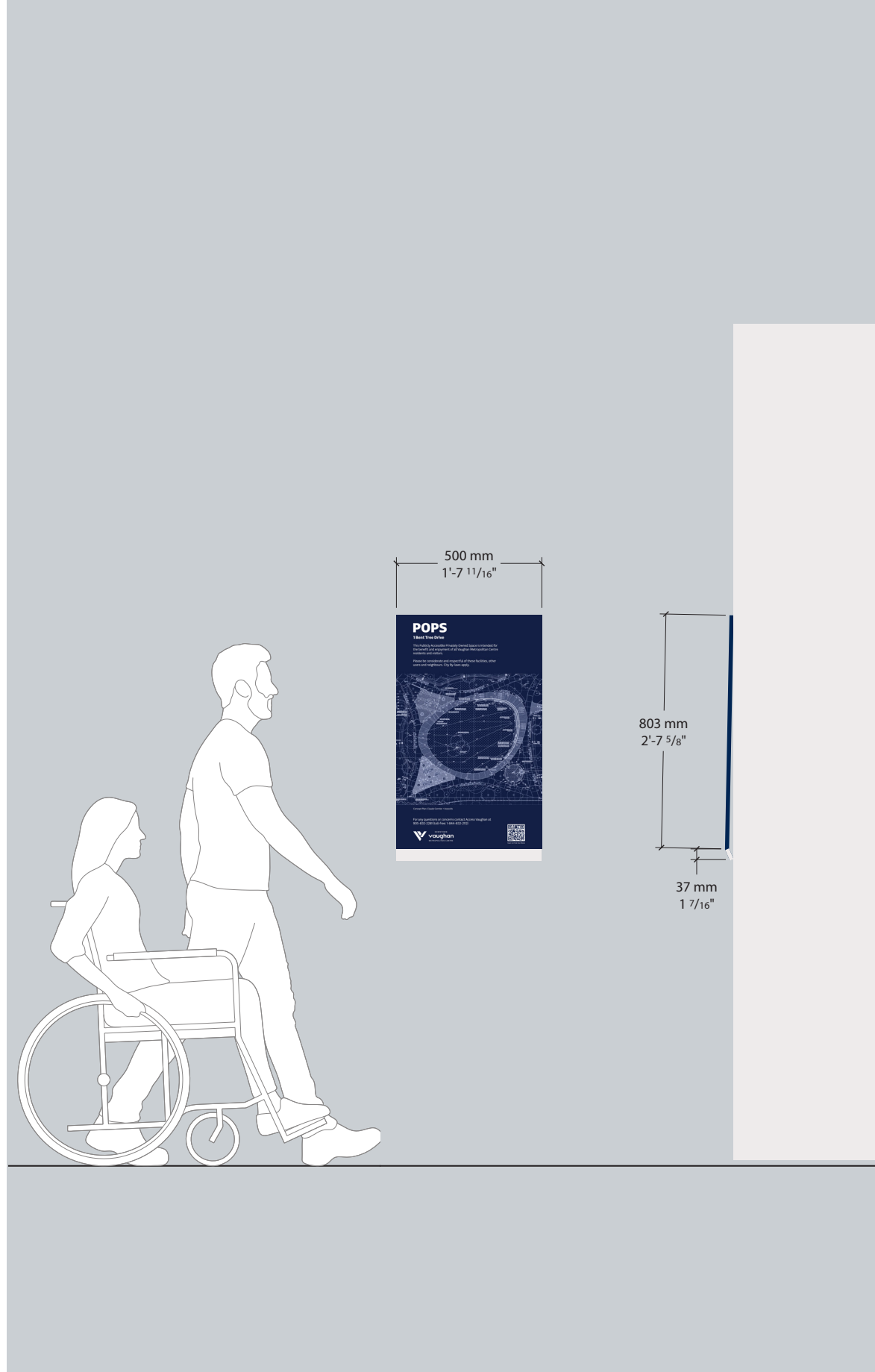

GRAPHIC ASSETS AND TECHNICAL DETAILS

ID2: Technical Details

Sign Type: ID2

(Powder coat only)

Sign Panels:

13mm thick aluminum panel pylon. All visible surfaces to be graphic print sublimated in powder coat. Possible suppliers include:

- Alto (altoaluminum.com)
- Direct Embed Coating (directembedcoating.com)
- Decora (decorapowdercoatings.com)

Fabricated Aluminum Structure:

All visible surfaces to be powder-coated to match Light Grey.

Colour:

Navy to match Pantone 655c

Blue to match Pantone 3005c

Light Grey to match Pantone 7541c

Text/Graphics: All text and graphic to be digitally applied powder coated.

Sign post, Foundation:

Mount sign structure onto finished concrete foundation.

Notes: General Artwork for face panel to be provided post award.

See the following technical detail pages for the interior structure and additional details.

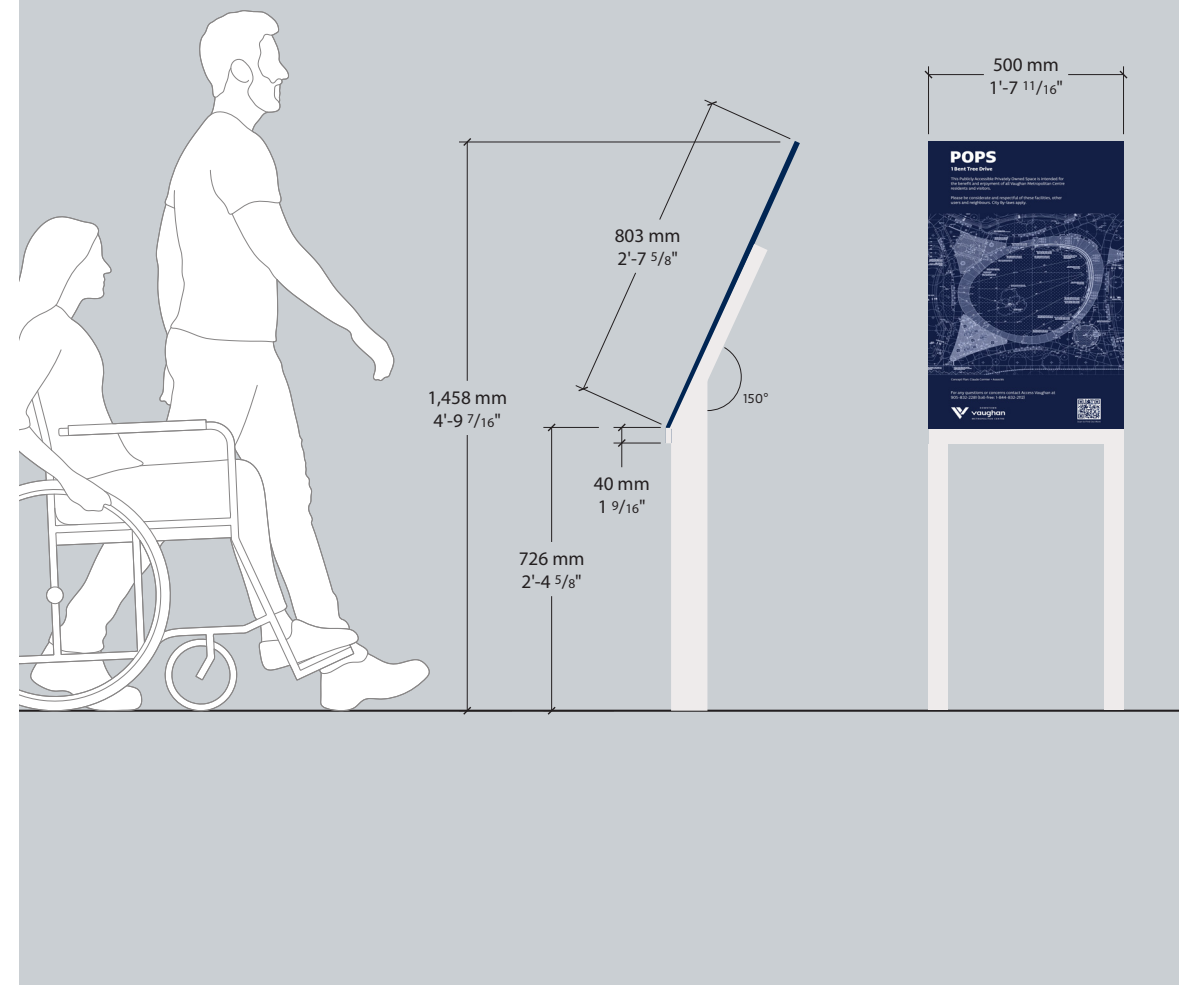

GRAPHIC ASSETS AND TECHNICAL DETAILS

ID2: Technical Details

- A** Aluminum Graphic Panel
13mm thick aluminum removable graphic panel. Add 40mm deep and 13mm thick aluminum overlap-groove and weld-fill and grind smooth exposed surfaces
- B** Aluminum Channel
51mm x 51mm x 6mm thick aluminum channel cross member -weld
- C** Aluminum Square Tube
51mm x 51mm x 6mm (w)-aluminum square tube-miter weld
- D** Counter Sunk Fastener
6mm dia. stainless steel counter sunk vandal proof flat head screws -thread into back of aluminum graphic panel
- E** Aluminum Rectangular Tube
51mm x 102mm x 6mm (w) aluminum rectangular tube leg- miter weld- cut rectangular hole through base plate and push through rec. tube leg and full weld top and bottom
- F** Pre-Cast Concrete Slabs
Pre-cast concrete slabs-may vary in size as per site condition (shown)-can install turf with filter cloth, asphalt on gravel, or concrete pavers -removable
- G** Aluminum Base Plate
25mm thick aluminum base plate-(Confirm with Structural Engineer)
- H** Washed Gravel Fill
Washed gravel fill as required
- I** Galvanized Threaded Rods
16mm dia. galvanized threaded rods with leveling nuts and washers-(Confirm with Structural Engineer)
- J** Concrete Pile
350mm dia. concrete pile with reinforcing-(Confirm with Structural Engineer)
- K** Halfen HD-Socket Lifting System
Halfen HD-socket Lifting System-short anchor6360-1,3-070A4 (oo21)-load capacity of 13 (kn)-with removable rotary head lifting link 6367 with sealing finish cap
- L** Concrete Pile Cap
Poured in place concrete pile cap with reinforcing (Confirm with Structural Engineer)

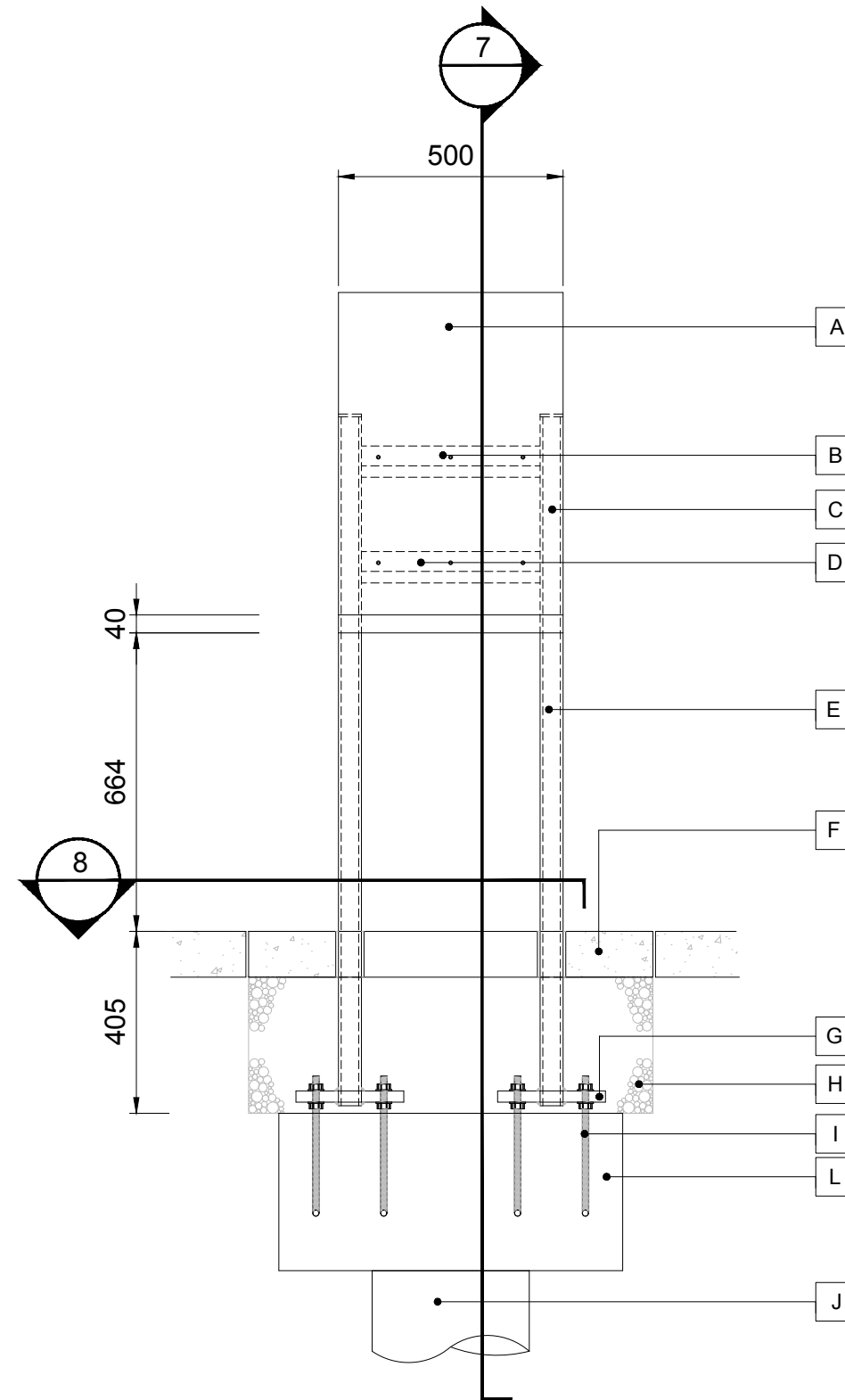

Front Elevation Framing
SCALE: 1:15

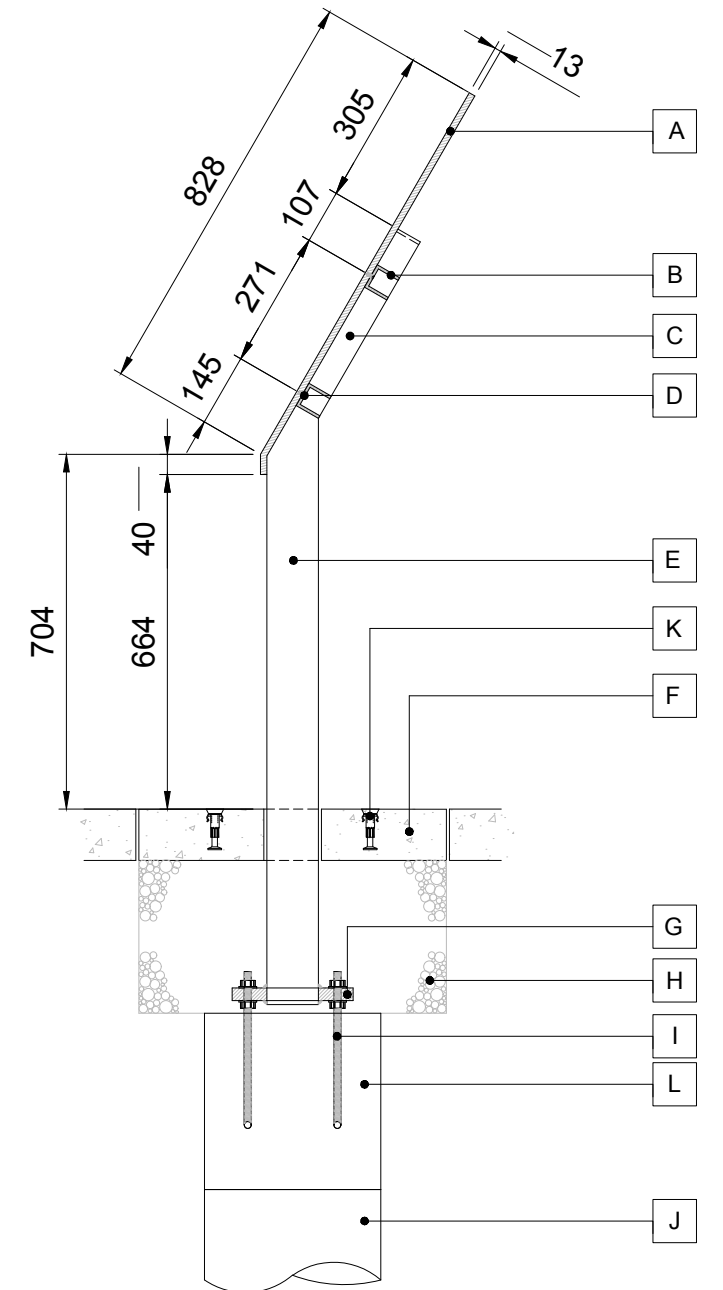

7 Section
SCALE: 1:15

GRAPHIC ASSETS AND TECHNICAL DETAILS

ID2: Technical Details

- A** Aluminum Graphic Panel
13mm thick aluminum removable graphic panel. Add 40mm deep and 13mm thick aluminum overlap-groove and weld-fill and grind smooth exposed surfaces
- B** Aluminum Channel
51mm x 51mm x 6mm thick aluminum channel cross member -weld
- C** Aluminum Square Tube
51mm x 51mm x 6mm (w)-aluminum square tube-miter weld
- D** Counter Sunk Fastener
6mm dia. stainless steel counter sunk vandal proof flat head screws -thread into back of aluminum graphic panel
- E** Aluminum Rectangular Tube
51mm x 102mm x 6mm (w) aluminum rectangular tube leg- miter weld- cut rectangular hole through base plate and push through rec. tube leg and full weld top and bottom
- F** Pre-Cast Concrete Slabs
Pre-cast concrete slabs-may vary in size as per site condition (shown)-can install turf with filter cloth, asphalt on gravel, or concrete pavers -removable
- G** Aluminum Base Plate
25mm thick aluminum base plate-(Confirm with Structural Engineer)
- H** Washed Gravel Fill
Washed gravel fill as required
- I** Galvanized Threaded Rods
16mm dia. galvanized threaded rods with leveling nuts and washers-(Confirm with Structural Engineer)
- J** Concrete Pile
350mm dia. concrete pile with reinforcing-(Confirm with Structural Engineer)
- K** Halfen HD-socket Lifting System
Halfen HD-socket Lifting System-short anchor6360-1,3-070A4 (oo21)-load capacity of 13 (kn)-with removable rotary head lifting link 6367 with sealing finish cap
- L** Concrete Pile Cap
Poured in place concrete pile cap with reinforcing (Confirm with Structural Engineer)

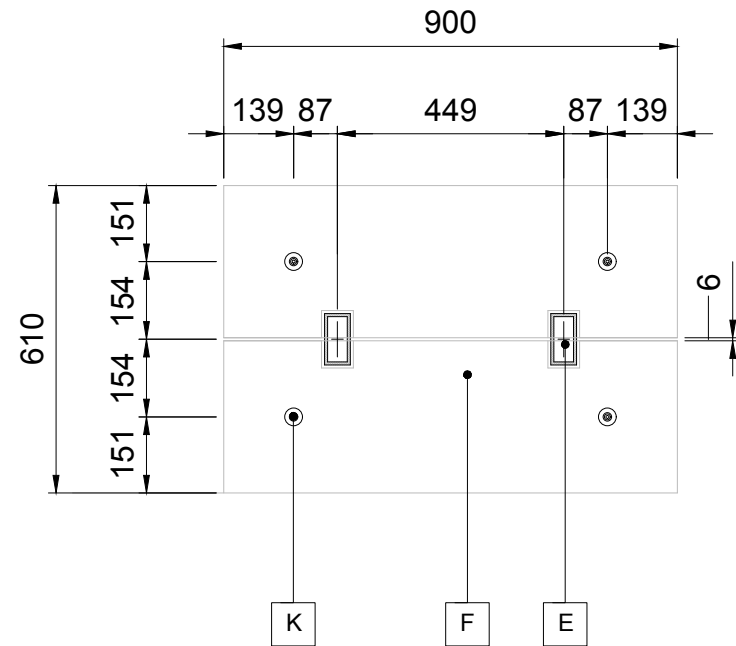

Top View
SCALE: 1:15

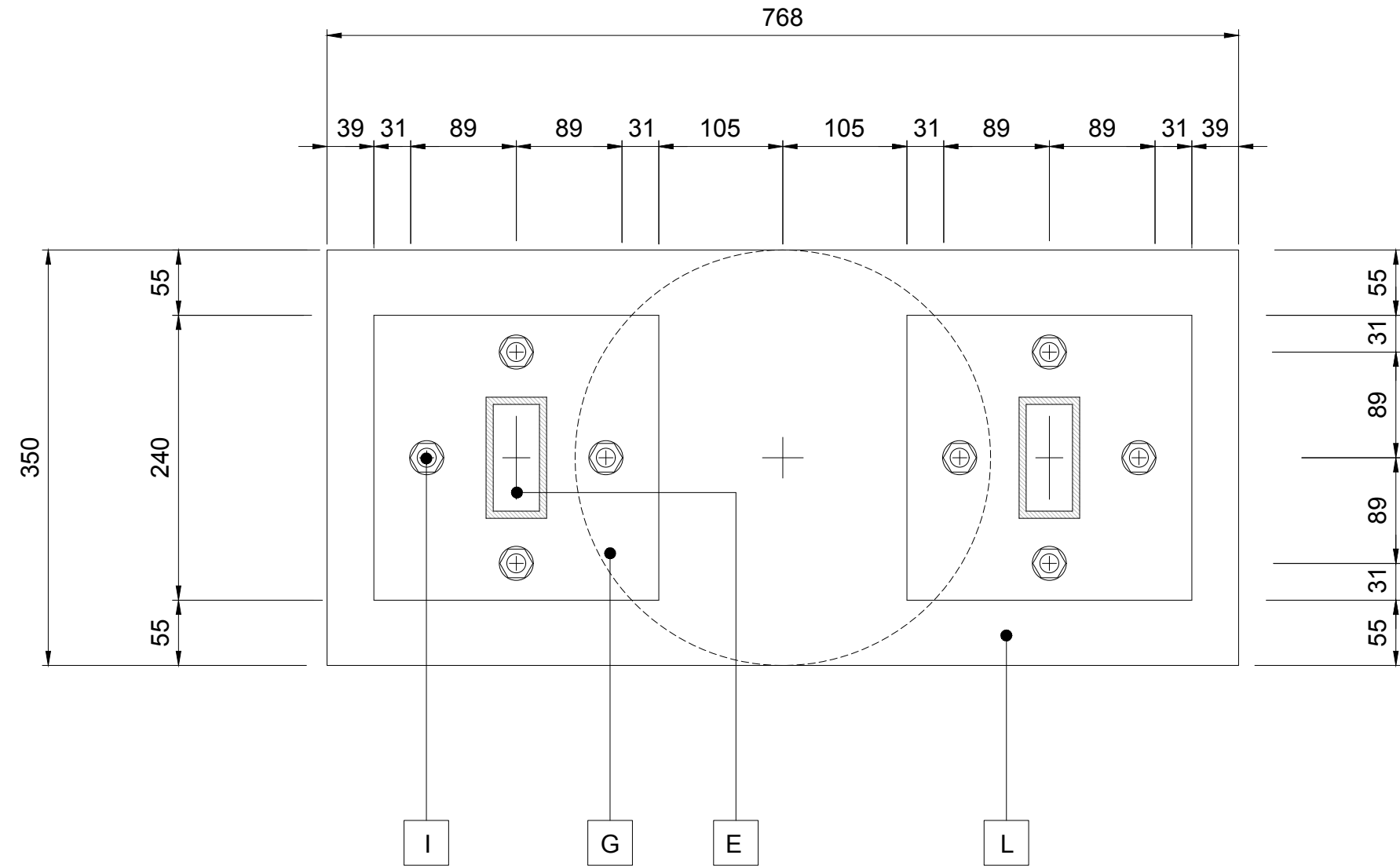

8 Section
SCALE: 1:5

GRAPHIC ASSETS AND TECHNICAL DETAILS

ID3: Technical Details

Sign Type: ID3

(Powder coat only)

Sign Panels:

13mm thick aluminum face panel with all visible surfaces to be graphic print sublimated in powder coat. Possible suppliers include:

- Alto (altoaluminum.com)
- Direct Embed Coating (directembedcoating.com)
- Decora (decorapowdercoatings.com)

Fabricated Aluminum Structure:

13mm thick aluminum angled aluminum panel to match Light Grey to be welded to face panel- weld and grind smooth-two part epoxy to serve as the support structure.

Colour:

Navy to match Pantone 655c

Blue to match Pantone 3005c

Light Grey to match Pantone 7541c

Text/Graphics: All text and graphic to be digitally applied powder coated.

Foundation/Base:

Fabricator provide base plate to allow sign to free-stand at the appropriate height for display purposes. No installation is required for this sign.

Notes: General Artwork for face panel to be provided post award.

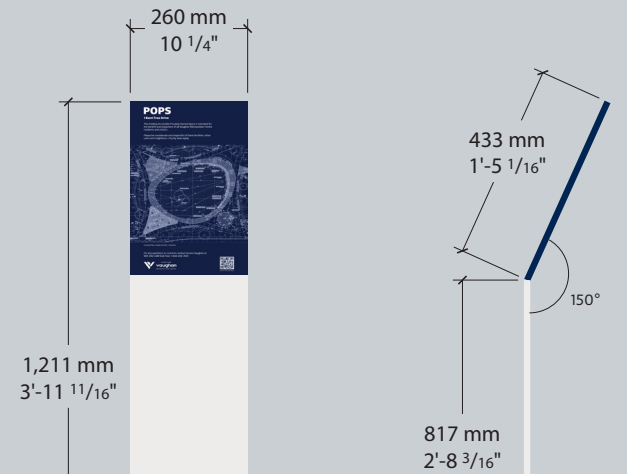

GRAPHIC ASSETS AND TECHNICAL DETAILS

ID3: Technical Details

- A** Aluminum Graphic Panel
13mm thick aluminum removable graphic panel. Add 40mm deep and 13mm thick aluminum overlap-groove and weld-fill and grind smooth exposed surfaces
- B** Aluminum Channel
51mm x 51mm x 6mm thick aluminum channel cross member -weld
- C** Aluminum Square Tube
51mm x 51mm x 6mm (w)-aluminum square tube-miter weld
- D** Counter Sunk Fastener
6mm dia. stainless steel counter sunk vandal proof flat head screws -thread into back of aluminum graphic panel
- E** Aluminum Rectangular Tube
51mm x 102mm x 6mm (w) aluminum rectangular tube leg- miter weld- cut rectangular hole through base plate and push through rec. tube leg and full weld top and bottom
- F** Pre-Cast Concrete Slabs
Pre-cast concrete slabs-may vary in size as per site condition (shown)-can install turf with filter cloth or concrete pavers -removable
- G** Aluminum Base Plate
25mm thick aluminum base plate-(Confirm with Structural Engineer)
- H** Washed Gravel Fill
Washed gravel fill as required
- I** Galvanized Threaded Rods
16mm dia. galvanized threaded rods with leveling nuts and washers-(Confirm with Structural Engineer)
- J** Concrete Pile
350mm dia. concrete pile with reinforcing-(Confirm with Structural Engineer)
- K** Halfen HD-Socket Lifting System
Halfen HD-socket Lifting System-short anchor6360-1,3-070A4 (oo21)-load capacity of 13 (kn)-with removable rotary head lifting link 6367 with sealing finish cap
- L** Concrete Pile Cap
Poured in place concrete pile cap with reinforcing (Confirm with Structural Engineer)

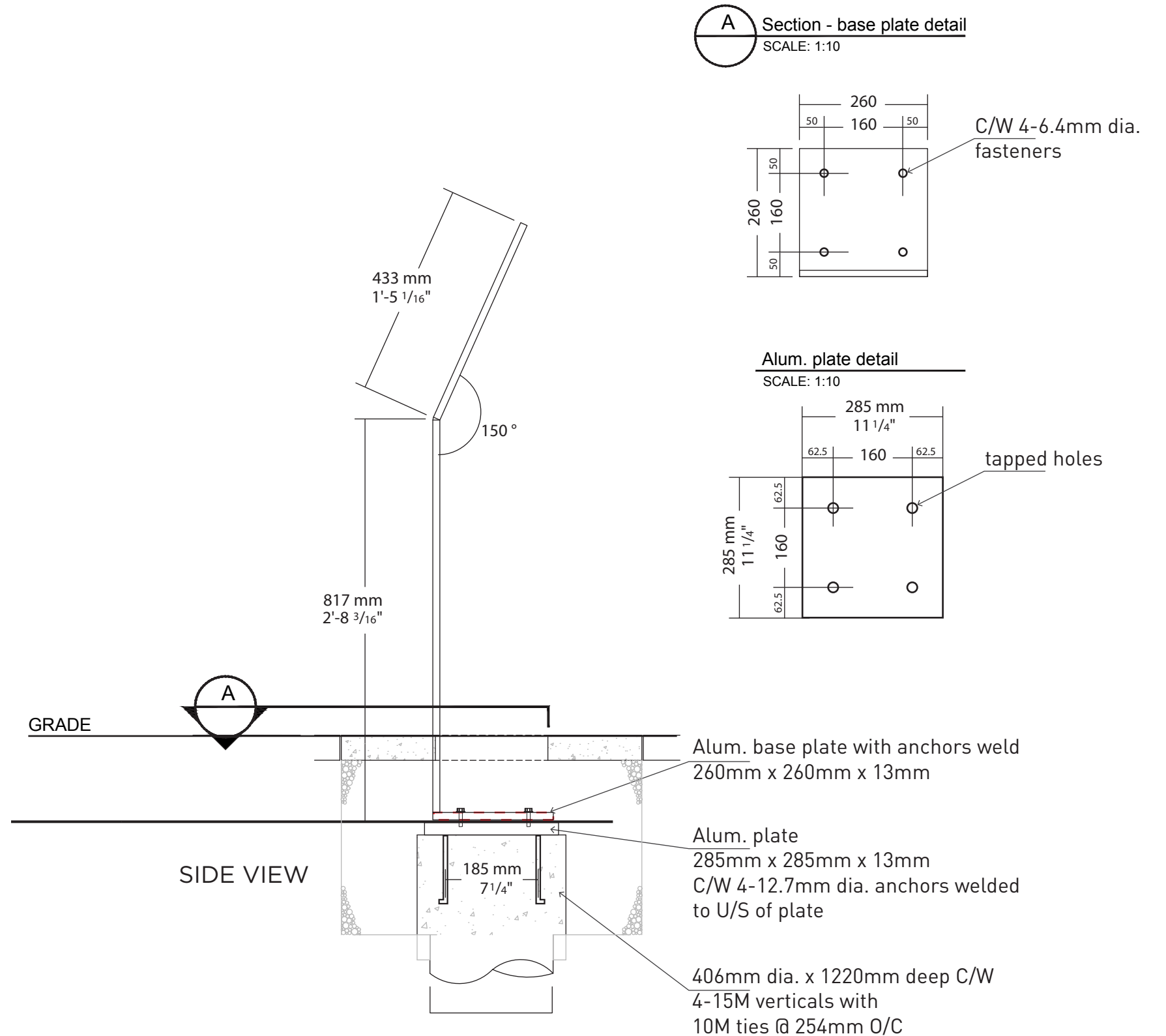
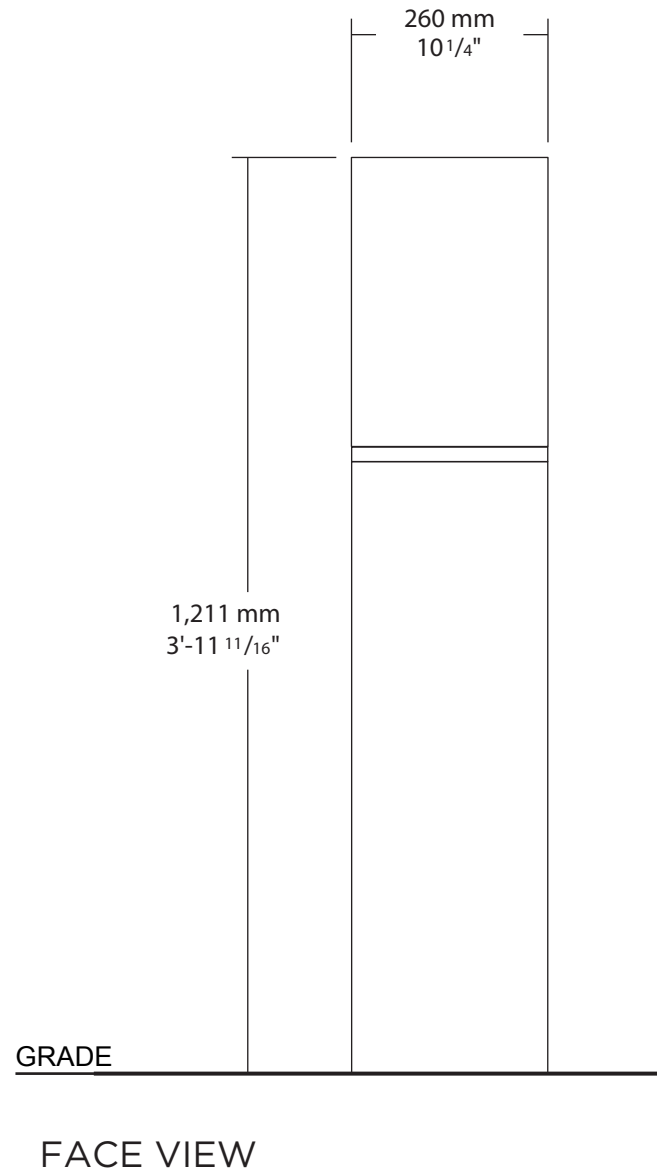

GRAPHIC ASSETS AND TECHNICAL DETAILS

T1: Technical Details

Sign Type: T1.1

(Powder coat only)

SIGN PANELS:

13mm thick aluminum panel pylon. All visible surfaces to be graphic print sublimated in powder coat. Possible suppliers include:

- Alto (altoaluminum.com)
- Direct Embed Coating (directembedcoating.com)
- Decora (decorapowdercoatings.com)

Angled aluminum panel to be welded to larger panel- weld and grind smooth-two part epoxy with powder coat to extend below grade.

Colour:

Navy to match Pantone 655c

Aqua to match Pantone 3265c

Light Grey to match Pantone 7541c

Text/Graphics:

All text and graphic to be digitally applied powder coated.

Sign post, Foundation:

Mount sign structure onto finished concrete foundation.

Notes:

General Artwork for facepanel to be provided post award.

See the following technical detail pages for the interior structure and additional details.

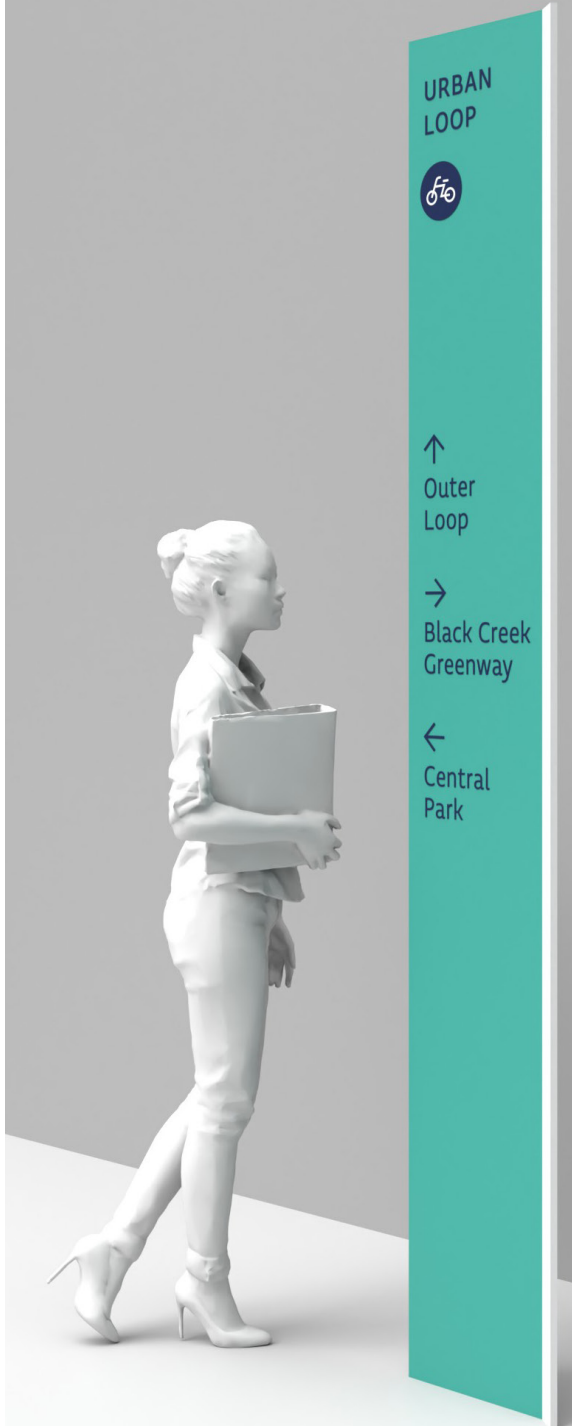
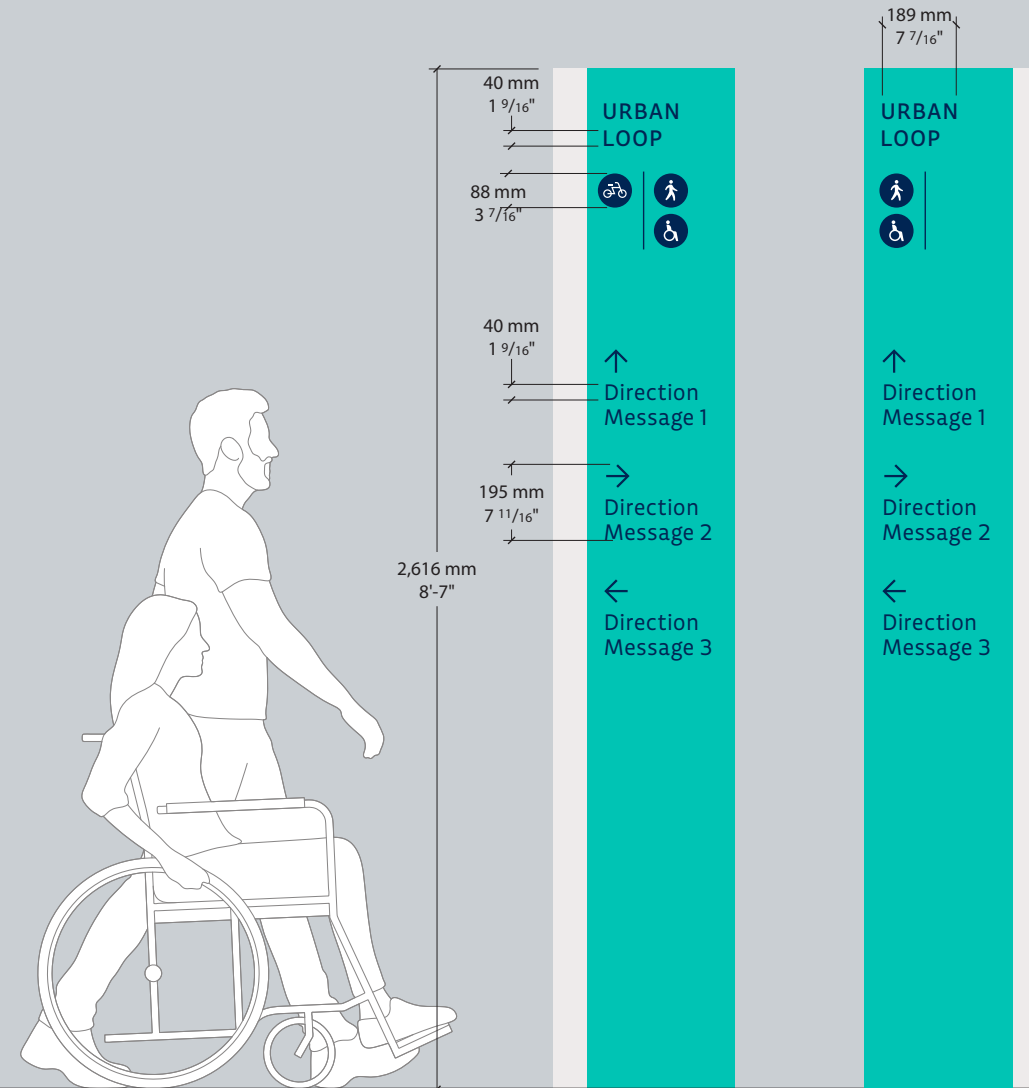
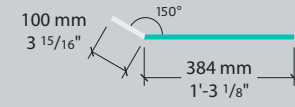

T1: Technical Details



Phone: 905.660.7310
 Toll Free: 1.888.236.4703
 Fax: 905.660.0777
 info@spectra-signs.com
 3-299 Basaltic Road
 Concord, ON
 L4K 4W8

SIGN TYPE: T1.1-04
 Trail Directional, Freestanding

PROJECT NUMBER: 220479

NOTE:
 DURING CONSTRUCTION DO NOT DISTURB THE SOIL ADJACENT THE GRADE BEAM,
 /OR COMPACT THE SOIL AROUND THE GRADE BEAM FOR IT TO BE EFFECTIVE.

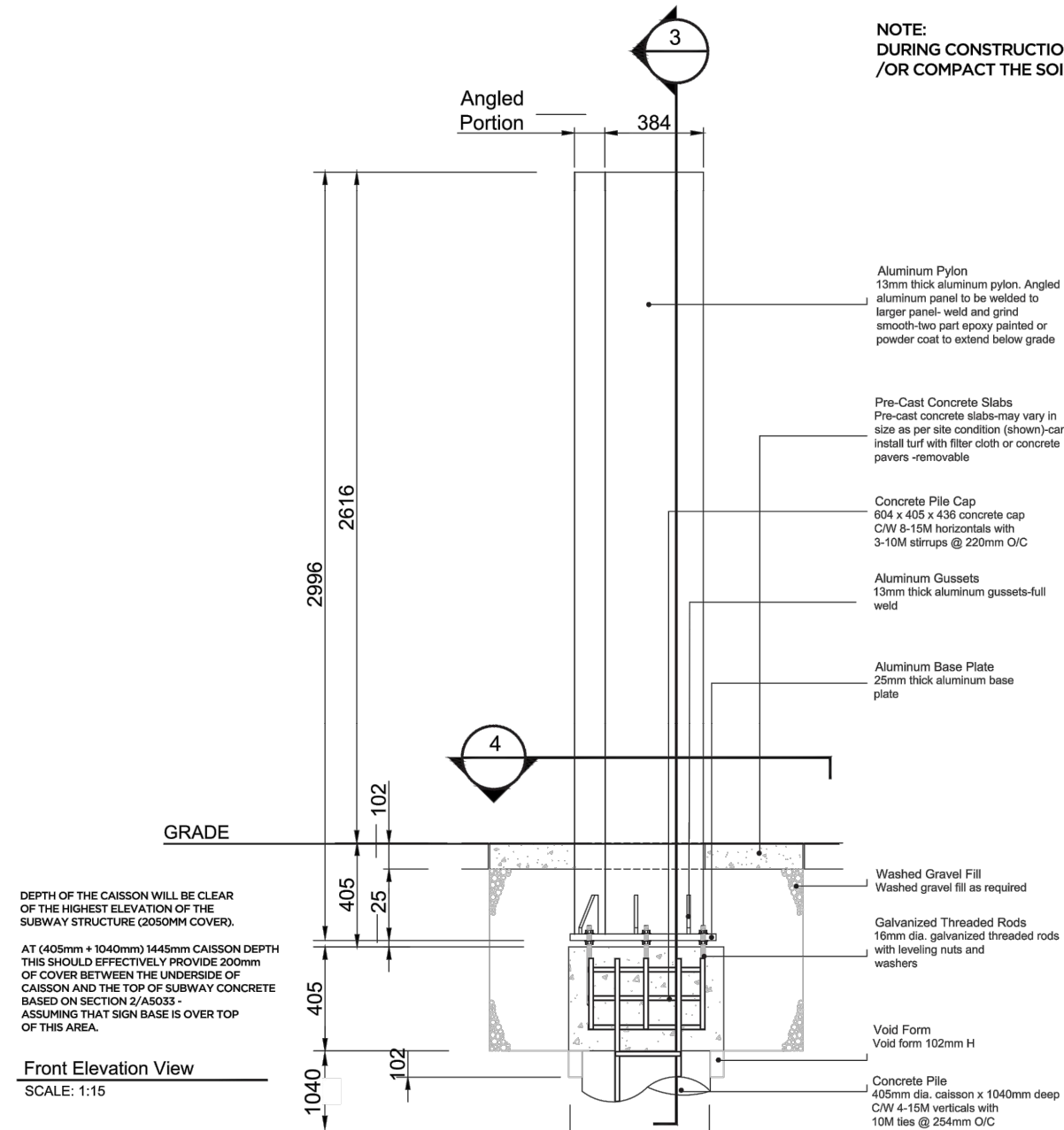

REVIEWED BY:

2121 ARGENTIA ROAD, 4TH FLOOR
 MISSISSAUGA, ONTARIO, L5N 2X4
 EXPERT@RIMKUS.COM
 (800) 580-3228 | (905) 607-7244

W/N: 100190298 | DATE: 06/01/2023

DESIGN LOADS AS PER ONTARIO BUILDING CODE 2012 AS AMENDED BY RESOLUTION 88/19 FOR VAUGHAN, ON
 S_s = 1.1 kPa
 S_r = 0.4 kPa
 q 1/50 = 0.44 kPa
 SPECIFIED WIND LOAD = 0.911 kPa
 FOR SIGN IDS3 - INTERIOR INSTALLATION - NO LATERAL LOAD

STEEL
 HSS - F_y = 350 MPa
 STEEL PLATES - F_y = 300 MPa
 ANCHOR BOLTS - A307 MIN.
 REINFORCING STEEL - F_y = 400 MPa

ALUMINUM
 MIN. F_y = 240 MPa

CONCRETE
 f'c = 25 MPa

SOIL
 γ = 19.0 kN/m³
 C_u = 30 kPa

DRAWINGS REVIEWED FOR SIGN STRUCTURAL MEMBERS AND CONCRETE DESIGN AND CONNECTION DESIGN ONLY.



3 Section
 SCALE: 1:15

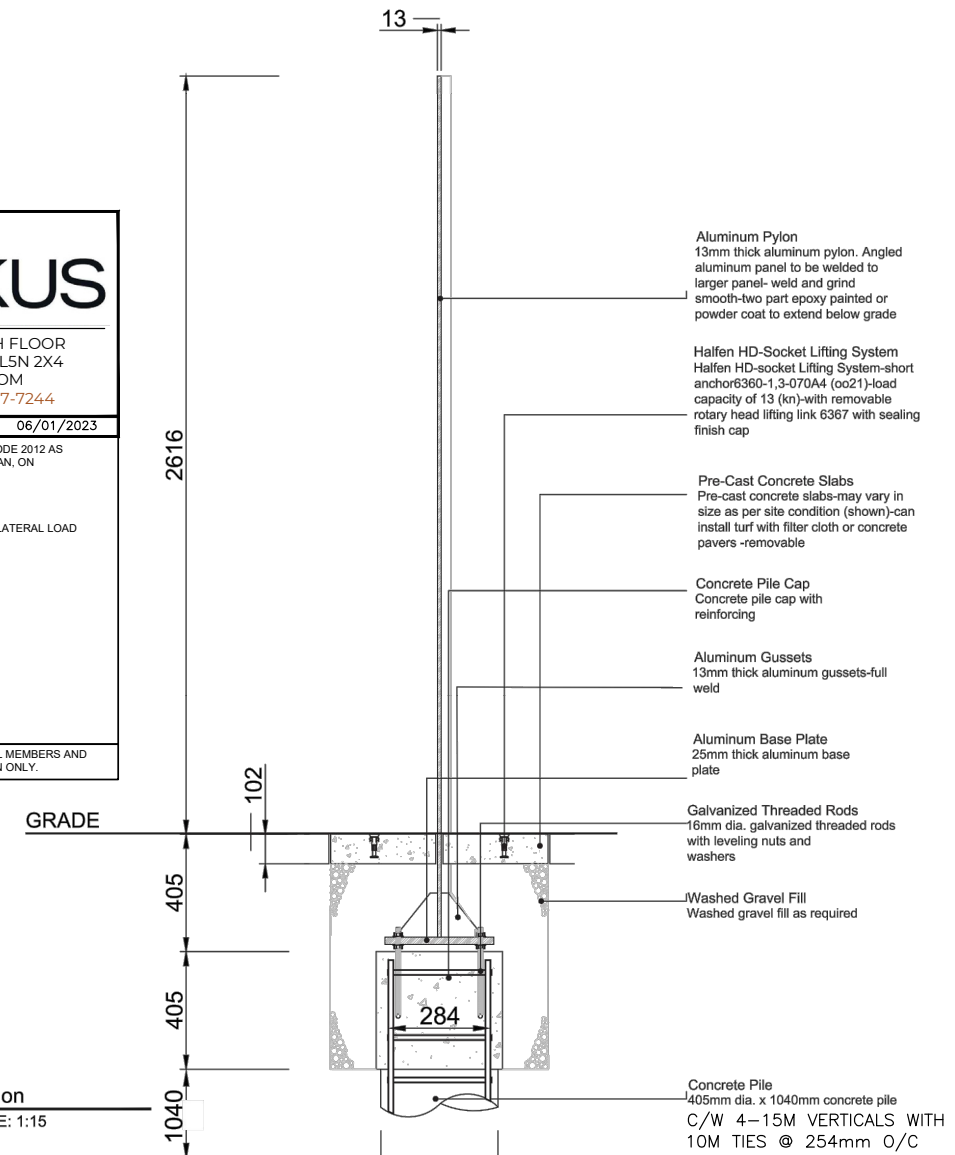

CLIENT
 Vaughan Metropolitan Centre

LOCATION
 3150 Hwy 7 | Vaughan, ON L4K 4R6

DESIGNER
 J.W.

PLEASE READ THE DISCLAIMER BELOW BEFORE APPROVING YOUR ARTWORK
 DESIGN NOTICE: WHEN PROVIDED A PROOF, IT IS THE CLIENT'S RESPONSIBILITY TO DOUBLE-CHECK AND THOROUGHLY PROOF-READ THE FOLLOWING: SPELLING, GRAMMAR, PUNCTUATION, ADDRESSES, PHONE NUMBERS, COLOUR, MATERIAL, SIZE & QUANTITY. ERRORS WILL BE FIXED AT NO ADDITIONAL CHARGE BUT CHANGES TO THE ORIGINAL DESIGN WILL BE CHARGED AT THE QUOTED HOURLY RATE. ANY ADDITIONAL COSTS INCURRED TO FIX ERRORS AFTER PRODUCTION ARE THE SOLE RESPONSIBILITY OF THE CLIENT.

T1: Technical Details



Phone: 905.660.7310
 Toll Free: 1.888.236.4703
 Fax: 905.660.0777
 info@spectra-signs.com
 3-299 Basaltic Road
 Concord, ON
 L4K 4W8

SIGN TYPE: T1.1-04

Trail Directional, Freestanding

PROJECT NUMBER: 220479

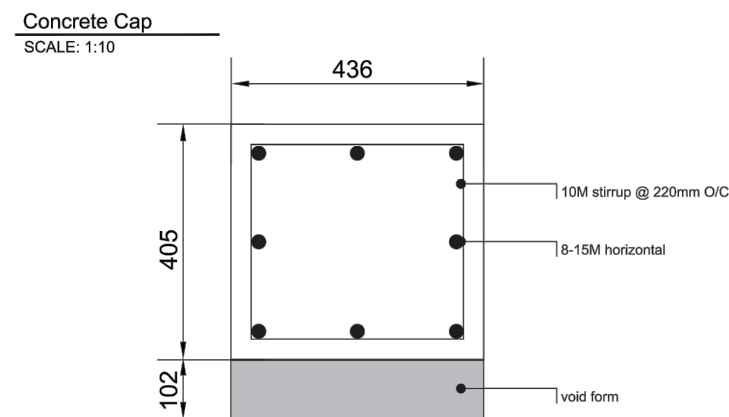
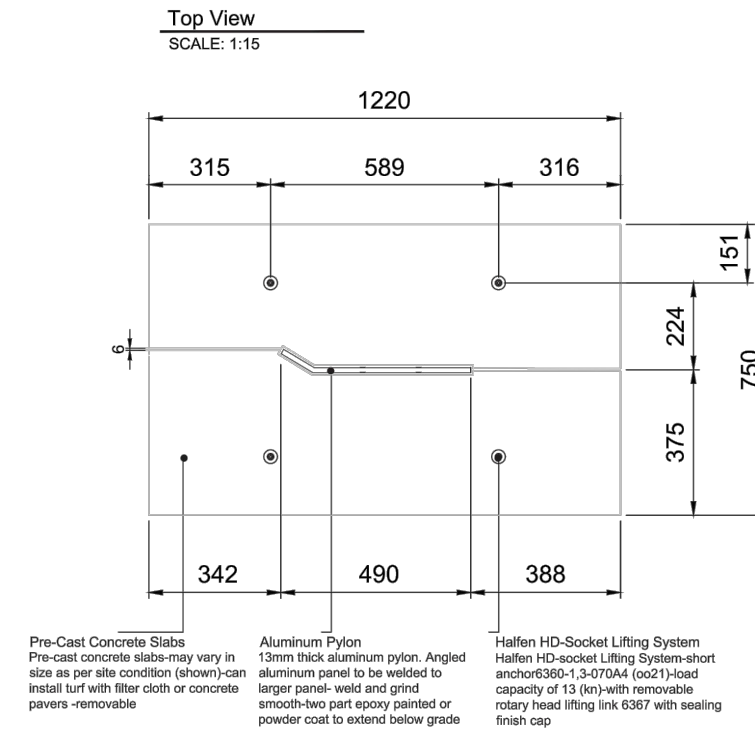
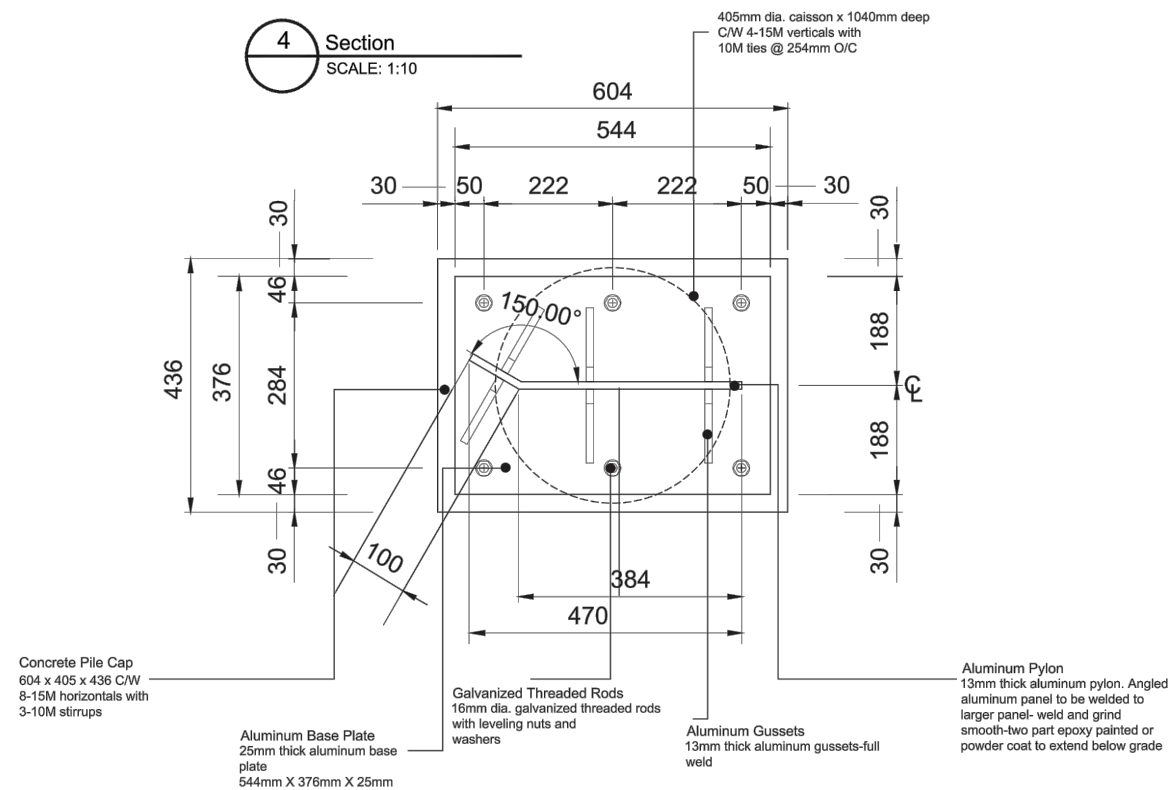

REVIEWED BY:

RIMKUS

2121 ARGENTIA ROAD, 4TH FLOOR
 MISSISSAUGA, ONTARIO, L5N 2X4
 EXPERT@RIMKUS.COM
 (800) 580-3228 | (905) 607-7244

W/N: 100190298 | DATE: 06/01/2023

DESIGN LOADS AS PER ONTARIO BUILDING CODE 2012 AS
 AMENDED BY RESOLUTION 88/19 FOR VAUGHAN, ON

S_s = 1.1 kPa
 S_r = 0.4 kPa
 q 1/50 = 0.44 kPa
 SPECIFIED WIND LOAD = 0.911 kPa
 FOR SIGN ID3 - INTERIOR INSTALLATION - NO LATERAL LOAD

STEEL
 HSS - F_y = 350 MPa
 STEEL PLATES - F_y = 300 MPa
 ANCHOR BOLTS - A307 MIN.
 REINFORCING STEEL - F_y = 400 MPa

ALUMINUM
 MIN. F_y = 240 MPa

CONCRETE
 f_c = 25 MPa

SOIL
 γ = 19.0 kN/m³
 C_u = 30 kPa

DRAWINGS REVIEWED FOR SIGN STRUCTURAL MEMBERS AND
 CONCRETE DESIGN AND CONNECTION DESIGN ONLY.

CLIENT
Vaughan Metropolitan Centre

LOCATION
3150 Hwy 7 | Vaughan, ON L4K 4R6

DESIGNER
J.W.

PLEASE READ THE DISCLAIMER BELOW BEFORE APPROVING YOUR ARTWORK
 DESIGN NOTICE: WHEN PROVIDED A PROOF, IT IS THE CLIENT'S RESPONSIBILITY TO DOUBLE-CHECK AND THOROUGHLY PROOF-READ THE FOLLOWING:
 SPELLING, GRAMMAR, PUNCTUATION, ADDRESSES, PHONE NUMBERS, COLOUR, MATERIAL, SIZE & QUANTITY. ERRORS WILL BE FIXED AT NO ADDITIONAL
 CHARGE BUT CHANGES TO THE ORIGINAL DESIGN WILL BE CHARGED AT THE QUOTED HOURLY RATE. ANY ADDITIONAL COSTS INCURRED TO FIX ERRORS
 AFTER PRODUCTION ARE THE SOLE RESPONSIBILITY OF THE CLIENT.

GRAPHIC ASSETS AND TECHNICAL DETAILS

T2: Technical Details

Sign Type: T2.1

(Powder coat with Bend edge Panel)

SIGN PANELS:

(A) 6 mm thick aluminum panel. All visible surfaces to be graphic print sublimated in powder coat with slip-proof coating. Possible suppliers for powder coat include:

- Alto (altoaluminum.com)
- Direct Embed Coating (directembedcoating.com)
- Decora (decorapowdercoatings.com)

Angled aluminum panel to be welded to larger panel- weld and grind smooth - two part epoxy. Fabricator to verify on site appropriate angle for side panel.

Colour:

Navy text and picto to match Pantone 655c

Aqua background to match Pantone 3265c

Text/Graphics:

All text and graphic to be digitally applied powder coated.

Foundation:

(B) Fabricator to provide additional concrete foundation to allow face panel to be mount on existing concrete curb.

Notes:

General Artwork for face panel to be provided. Fabricator to verify site condition. Approximate location and details including fastening to be finalize post award.

Sign Type: T2.2

(Powder coat with Paint on Concrete Curb)

SIGN PANELS:

(C) 6 mm thick aluminum panel with All visible surfaces to be graphic print sublimated in powder coat with slip-proof coating. Possible suppliers for powder coat include:

- Alto (altoaluminum.com)
- Direct Embed Coating (directembedcoating.com):
- Decora (decorapowdercoatings.com)

Painted Concrete Surface:

(D) Paint to match Aqua on surface of foundation, existing curb and edge.

Colour:

Navy text and picto to match Pantone 655c

Aqua background to match Pantone 3265c

Text/Graphics:

All text and graphic to be digitally applied powder coated.

Foundation:

(B) Fabricator to provide additional concrete foundation to allow face panel to be mount on existing concrete curb.

(E) Fabricator to ensure end of concrete foundation is round off in an elegant angle with existing curb, details TBD, visual for example only.

Notes:

General Artwork for face panel to be provided. Fabricator to verify site condition. Approximate location and details including fastening to be finalize post award.

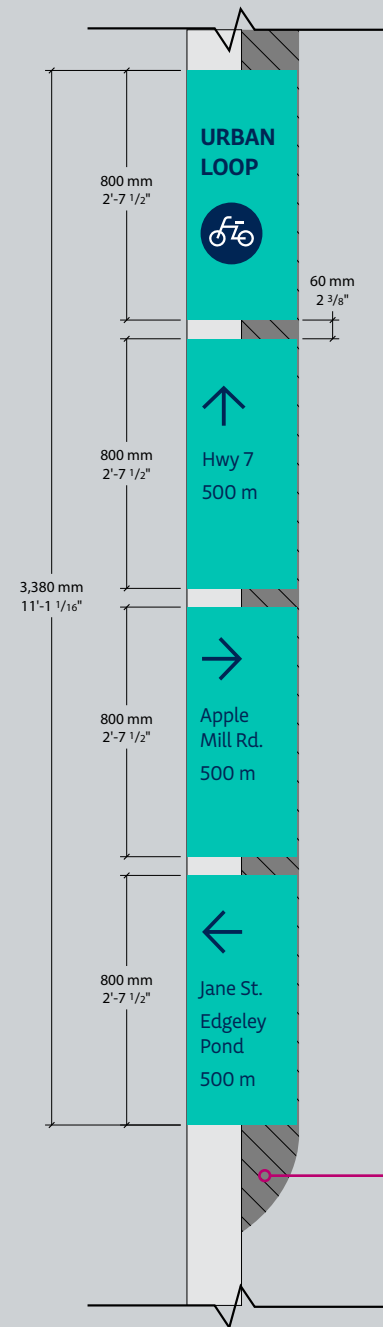

Sign Type: T2.1

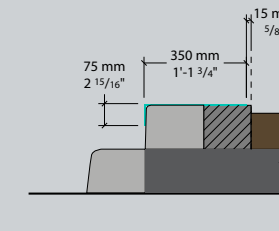
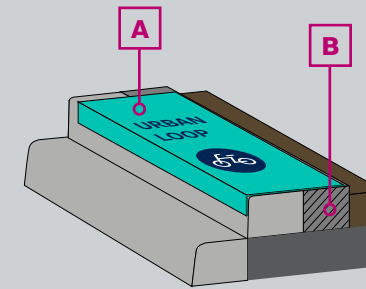

Sign Type: T2.2

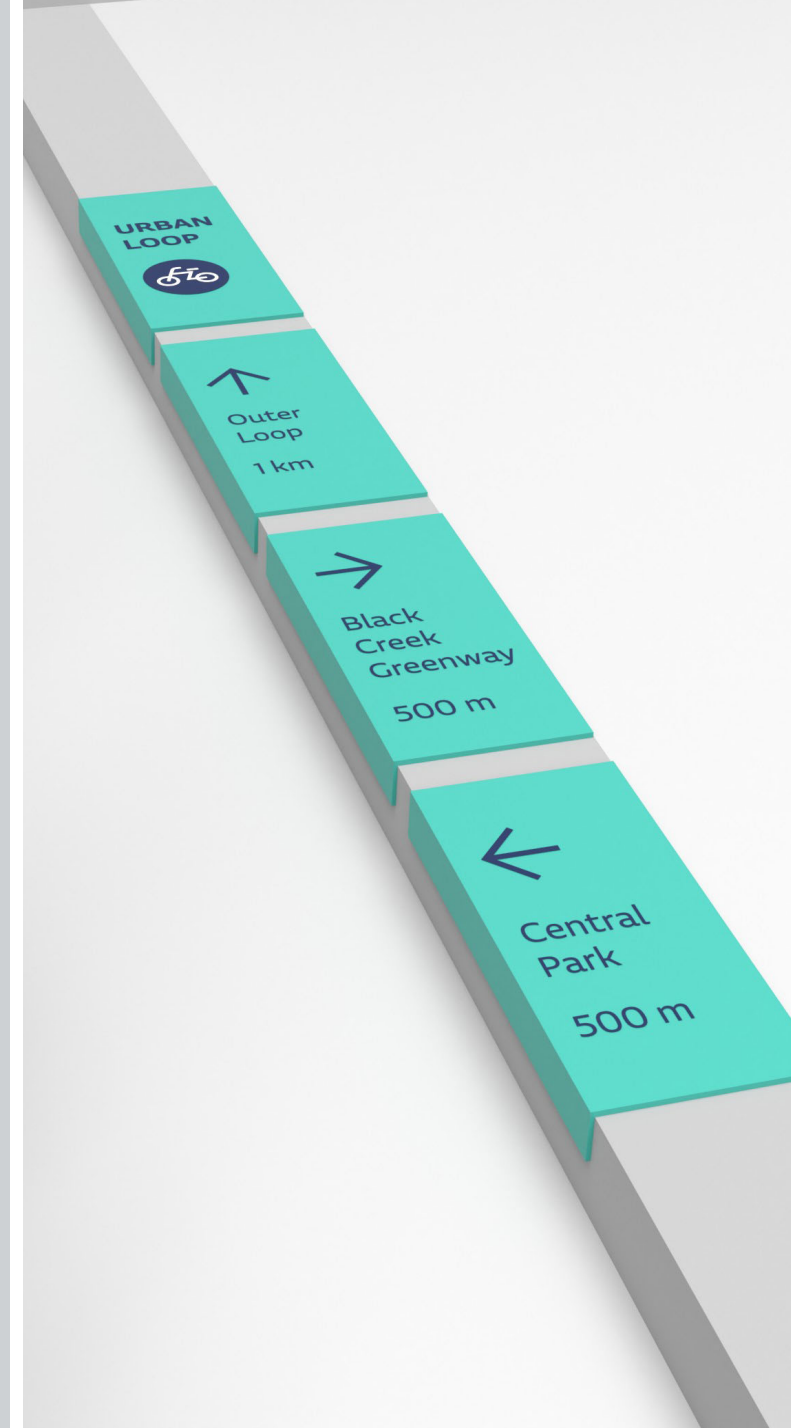
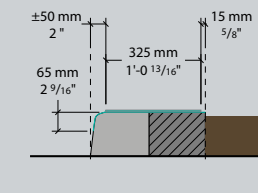
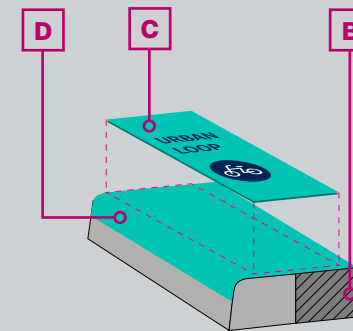

T2: Technical Details



Phone: 905.660.7310
 Toll Free: 1.888.236.4703
 Fax: 905.660.0777
 info@spectra-signs.com

3-299 Basaltic Road
 Concord, ON
 L4K 4W8

SIGN TYPE: T2.1-05, T2.2-06

Bicyclist Directional, Curb Sign

PROJECT NUMBER: 220479

SIGN TYPE: T2.1-05, T2.2-06
 SCALE: 1:25
 QTY: 2

Sign Type T2.1.05- set of four (4) 6mm thick aluminum panel, overall size to be 800 mm tall x 425 mm wide with bend at 74 mm

Panel to receive Direct Embed custom powder coat graphic finish on first surfaces and all edges per client supplied art file

Sign Type T2.2.06- set of four (4) 6mm thick aluminum panel, overall size to be 800 mm tall x 350 mm wide, panel to receive Direct Embed custom powder coat graphic finish on first surfaces and all edges per client supplied art file

Text/Graphics:
 All text and graphic to be digitally applied powder coated
 Typeface: Echo Pro Bold/Echo Pro Regular
Colour:
 Navy to match Pantone 655c
 Aqua to match Pantone 3265c

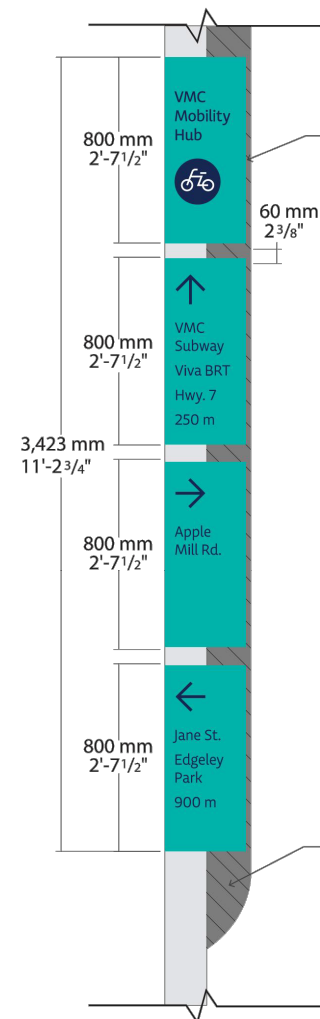

finishing of the concrete curb based on site conditions, round the curb if required

SIGN TYPE: T2.1-05
 QTY: 1 SET OF FOUR (4) PANELS

6 mm thick aluminum panel. All visible surfaces to be graphic print sublimated in powder coat with slip-proof coating.

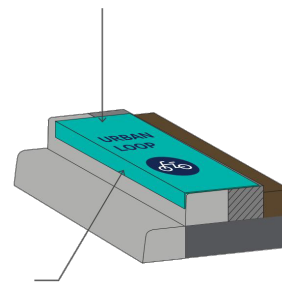

Angled aluminum panel to be welded to larger panel- weld and grind smooth - two part epoxy. appropriate angle for side panel to be verified on site

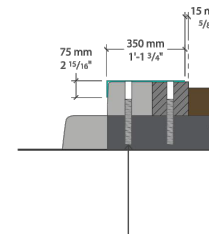

Panels mounted to curb with pins and epoxy.

SIGN TYPE: T2.2-06
 QTY: 1 SET OF FOUR (4) PANELS

Painted Concrete Surface:
 Paint to match Aqua on surface of foundation, existing curb and edge.

provide additional concrete foundation to allow face panel to be mount on existing concrete curb

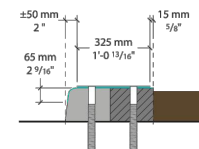
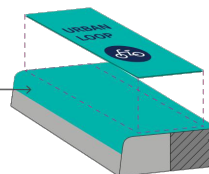

REVIEWED BY:

2121 ARGENTIA ROAD, 4TH FLOOR
 MISSISSAUGA, ONTARIO, L5N 2X4
 EXPERT@RIMKUS.COM
 (800) 580-3228 | (905) 607-7244

W/N: 100190298 DATE: 06/01/2023

DESIGN LOADS AS PER ONTARIO BUILDING CODE 2012 AS AMENDED BY RESOLUTION 88/19 FOR VAUGHAN, ON

S_s = 1.1 kPa
 S_r = 0.4 kPa
 q₁₅₀ = 0.44 kPa
 SPECIFIED WIND LOAD = 0.911 kPa
 FOR SIGN ID3 - INTERIOR INSTALLATION - NO LATERAL LOAD

STEEL
 HSS - F_y = 350 MPa
 STEEL PLATES - F_y = 300 MPa
 ANCHOR BOLTS - A307 MIN.
 REINFORCING STEEL - F_y = 400 MPa

ALUMINUM
 MIN. F_y = 240 MPa

CONCRETE
 f'c = 25 MPa

SOIL
 γ = 19.0 kN/m³
 C_u = 30 kPa

DRAWINGS REVIEWED FOR SIGN STRUCTURAL MEMBERS AND CONCRETE DESIGN AND CONNECTION DESIGN ONLY.

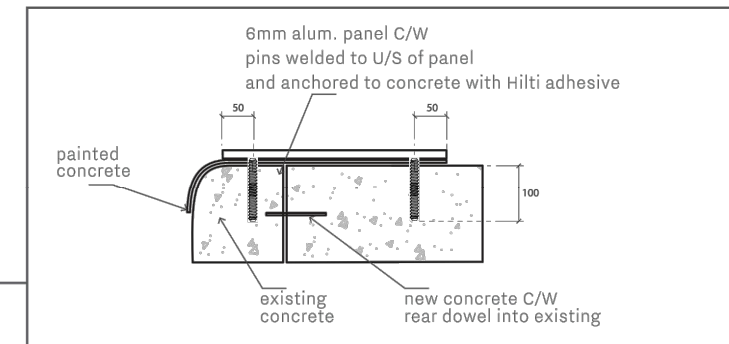

NOTE: INTERIOR LOCATIONS ONLY

NOTES:
SIGN T2.1-05, T2.2-06
 Supply and install two (2) signs.
GRAPHICS / SUBSTRATE
 6mm thick alum. panel with bend to receive Direct Embed custom powder coat graphic finish.
INSTALLATION METHOD
 Mount sign structure onto curb with pins and epoxy.

COLOUR
 ■ PMS 655C - Navy
 ■ PMS 3265C - Aqua

CLIENT
 Vaughan Metropolitan Centre

LOCATION
 3150 Hwy 7 | Vaughan, ON L4K 4R6

DESIGNER
 J.W.

PLEASE READ THE DISCLAIMER BELOW BEFORE APPROVING YOUR ARTWORK
 DESIGN NOTICE: WHEN PROVIDED A PROOF, IT IS THE CLIENT'S RESPONSIBILITY TO DOUBLE-CHECK AND THOROUGHLY PROOF-READ THE FOLLOWING: SPELLING, GRAMMAR, PUNCTUATION, ADDRESSES, PHONE NUMBERS, COLOUR, MATERIAL, SIZE & QUANTITY. ERRORS WILL BE FIXED AT NO ADDITIONAL CHARGE BUT CHANGES TO THE ORIGINAL DESIGN WILL BE CHARGED AT THE QUOTED HOURLY RATE. ANY ADDITIONAL COSTS INCURRED TO FIX ERRORS AFTER PRODUCTION ARE THE SOLE RESPONSIBILITY OF THE CLIENT.

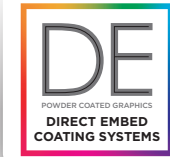

Direct Embed® Coating System Technical Specifications

Direct Embed Coating System is a highly customized sign printing technology developed by Direct Embed Coating Inc. based on powder coated graphics, a durable sublimated photo quality methodology for outdoor and indoor signs. Direct Embed powder coating utilizes high quality, heat treated aluminum alloy sheeting with an organic material under controlled conditions. This coating is fused with the aluminum and becomes the substrate upon which ink is applied, eliminating paper, vinyl or plastic from the printing process. Once imaging is completed, an organic topcoat is applied, fused and bonded with the ink and substrate, sealing the image between the topcoat and substrate. This protects the four-color print from harmful UV rays, water, hail, sand, rain, graffiti and vandalism.

Imaging

The Direct Embed Coating System process is done on a flatbed inkjet printer utilizing inks that have been carefully tuned to the process. Utilizing input resolutions ranging between 200 and 300 dpi, the output resolution is printed at 1200 dpi, providing accurate, bright and vibrant reproduction of continuous tone photographic images. This technology is also well-suited to reproducing small text and fine detail with amazing accuracy. All images are created in CMYK color space.

Attributes

Direct Embed® technology and fabrication creates highly durable signs with the following attributes:

- The only durable printing methodology capable of complex dimensional shapes and forms
- Can be integrated into large architectural projects
- Capable of curved and perforated surfaces and meshes
- Low cost of ownership
- Bright, vibrant graphics
- Self supporting in most common sign sizes
- Extremely strong
- Substantially lighter than other durable sign technologies
- Will not corrode if vandalized
- Graffiti cleans off easily with available cleaners
- Scratch resistant
- Superb UV protection (10-year warranty)
- Excellent weather and impact resistance
- Vandal resistant
- Will not delaminate
- Will not blister, crack or peel
- Signs available in thicknesses from .023 to .250 inches
- Direct Embed® fabrication also enables in flexible, wrapable graphics
- Available in contoured shapes, with or without mounting holes and with or without stainless steel studs and tamper-proof hardware on the reverse side of the sign
- Direct Embed® signs are printable on one side or both sides of the sign
- Direct Embed® signs are heat-treated to prevent expansion, contraction and curl

Sign Applications

Direct Embed® printing technology is designed to produce durable photo-quality color images on flat or three-dimensional surfaces. Working with aluminum, steel, glass, ceramic, and various other sustainable materials, Direct Embed® Coating System is the perfect solution to high-traffic locations or remote outdoor areas. Backed by up to 10 years of warranty, it is one of the world's most durable interior and exterior processes creating hydrophobic, graffiti and vandal resistant finish. It performs well in all climates: in direct sun, shady humid areas, extreme mountain conditions, seashores, and arid deserts. Applications of the Direct Embed® signs include:

- Wayfinding signs (parks, trails, campuses, business parks, malls, etc.)
- Interpretive signs and displays
- Exhibit signs, displays and murals
- Regulatory signs
- Corporate identity signage
- Museum signage
- Zoos and aquariums
- Retail signage (restaurants, bars, retail stores, etc.)
- Parking lot and garage signage
- Resort, theme park and recreational facility signage
- Architectural signage
- Monument signs (city welcome signs, park entrance, sub-divisions, industrial parks, etc.)
- Institutional signage (universities, government facilities, hospitals, etc.)
- Gas station/convenience store signage

Dimensional Shapes and Forms

Direct Embed® is capable of integrating graphics into complex dimensional forms. When developing dimensional objects make sure to consult Direct Embed staff closely, including both specifically sized graphics and a digital dimensional model of possible. For perforated forms Direct Embed will provide a sample of visual approach.

Standard Panel Thicknesses

Direct Embed® printing is used on three different configurations of signs with varying thicknesses:

Rigid signs

Direct Embed® signs have a standard thickness of .125 inches and are rigid enough to perform well without a backer plate or frame up to 24 x 36 inches on free-standing exhibit bases. If the sign is to be mounted on an exhibit base and is larger than 24 x 36 inches, a frame is recommended. Free-standing, framed Direct Embed® signs can be sized up to 36 x 48 inches without concerns about structural integrity. Vertical surface mountings do not have this restriction. Custom thicknesses up to .250 inches are available upon request.

NOTE: Temperature extremes have been known to cause expansion and contraction of outdoor signs with alternate sign technologies such as HPL, Fiberglass Embedment, Polycarbonate and Porcelain Enamel. Direct Embed® sign panels are heat treated at the factory to significantly reduce and/or prevent expansion, contraction and curling of the signs.

Flexible Signs

Direct Embed® printing technology is also used to print flexible aluminum signs that can wrap a post down to 4 inches in diameter. The standard aluminum substrate material on our flexible wrap signs is .032 inches which can wrap a round object down to 6 inches in diameter.

Powder Coating Specification & Maintenance

Sign Panel Mounting Options

Extruded frames

These attractive extruded frames can be powder coated with mitered corners to create an attractive mounting configuration for Direct Embed Coating sign panels. These frames can then be mounted to any number of exhibit base configurations including upright legs and cantilevered stands.

Bolt-through

Specify location and size of hole required for mounting the sign panels. The holes will be pre-cut and coated at the factory. Tamper-proof hardware is available if required.

Z-clip mounting

This mounting configuration includes clips that are screwed to the wall and clips adhered to the back of the sign which interlock to form a secure mounting.

Stainless steel studs

In those applications where the sign panel is to be mounted to another sign or to a back plate with concealed hardware, stainless steel studs on the back side of the sign are an excellent option. We offer flush mounted, stainless steel studs which are adhered to the backside of the sign panel with an adhesive. Each stud has a plate welded to the stud, creating a large surface on which to secure our bond with the aluminum sign. The studs are available with or without tamper-proof nuts and washers. The specifications on each stud size are indicated in the chart below. Each stud size has been engineered to provide high tensile and shear strength, ensuring that the sign panels are secure once mounted. Please see the chart below to select the appropriate stud size.

Stainless Steel Stud Selection Chart

STUD SPECIFICATION	LENGTHS AVAILABLE (IN)	PLATE DIAMETER & THICKNESS (IN)	TENSILE STRENGTH (LBS/STUD)	SHEAR STRENGTH (LBS/STUD)
1/4 X 20	.75, 1.0, 1.5, 1.75, 2.0, 2.5	1.25 X .058	500	650
5/16 X 18	1.5	2.0 X .080	1200	1500
3/8 X 16	.75, 2.0	2.0 X .080	1200	1500

Note: Stud material is Type 304 Stainless Steel

Tamper Proof Nuts and Washers

SIZE	WIDTH (IN)	DIAGONAL WIDTH (IN)	HEIGHT (IN)
1/4 X 20	1.05	1.28	.23
5/16 X 18	1.05	1.28	.23
3/8 X 16	1.05	1.28	.23

Note: Add washer thickness to nut height dimension to get the exact required height

Panel Sizes

Rectangular signs printed with Direct Embed® technology are available in sizes up to 48" x 120". If the sign is specified as a contoured shape, the maximum width of the sign panel cannot exceed 47 3/4", allowing 1/8 inch on each side for cutting. Murals of any size can be created by tiling Direct Embed® panels together. When creating murals, the graphics will be indexed over the entire surface of the mural.

Contoured Shapes

Direct Embed® signs can be cut to most shapes on our CNC routers. The minimum size router bit we utilize is a 1/8 inch bit. This determines the maximum inside angles we can cut on the sign panels.

Note: It's standard practice to round all panels (except tiled) with a minimum of 1/8 inch radius, to minimize sharp corners. Please specify the radius of the corners on any panels ordered.

ASTM Mechanical Performance Specifications

MECHANICAL PROPERTIES	ASTM TEST	GRADING
Scratch resistance	E-18	Meets or exceeds 8H Pencil Test
UV resistance	G115; D7238	Delta E <10.0
Gloss level	D523	35 ±5 gloss units
Abrasion resistance	D4060-10; D968-05	Pass/Fail test
Indentation hardness	N/A	Barcol rating = 56B
Impact resistance	D2794-93	>60 in. lbs/inch
Clarity	D1003	Clarity of underlying images
Chemical and stain resistance	D1308	No damage to finish when doing spot test
Fire/flame/smoke resistance	E84	Class A rating
Corrosive weather resistance	D1654; B-117	<5 mm creep when exposed to acidic salt spray
Adhesion	D3359	5B classification
Chalking	D4214	No chalking for 10 years
Hydrophobic	N/A	Highly graffiti resistant

Standard weights

Direct Embed® signs vary in weight based on the thickness of the aluminum used in its construction

SIGN TYPE	THICKNESS	WEIGHT / SQFT
Direct Embed® - Rigid	.125"	1.75 LBS
Direct Embed® - Rigid	.250"	3.53 LBS
Direct Embed® Flexible	.032"	0.45 LBS

Note: Contact factory for thicknesses and/or weights not shown on the chart above if required.

Powder Coating Specification & Maintenance

Sign finish Outdoor signage is generally subject to exposure to bright daylight conditions which can cause glare and compromise the ability to read the sign. For this reason, we have designed Direct Embed® signs with a gloss level that provides optimal clarity and sign visibility in conditions ranging from bright sunshine to shade.

Cleaning When removing pine sap, dampen a soft cloth with mineral spirits, denatured alcohol or isopropyl alcohol and gently rub the surface until the sap is gone. Direct Embed® Systems LLC's Graffiti- ZAP works best at dissolving the sap without damaging the surface. After removing sap from the sign's surface, or anytime the Direct Embed® signs are cleaned, use mild soap and water to remove oily films, dirt, dust, road film and other naturally occurring contaminants from the finish. Do not use abrasive cleaners or acids on the surface as it may damage the finish.

Graffiti removal Cleaning graffiti (especially paints) off Direct Embed® signs is much easier if you get to it within 24 - 48 hours. Crayon, permanent markers, inks and paints can generally be removed from Direct Embed® signs easily using Direct Embed® Systems LLC's Graffiti-XXX organic graffiti remover. Other possible cleaners to try are methyl alcohol, butanol, or isopropyl alcohol. All of these cleaners are mild solvents and can cause skin irritations. We recommend wearing protective gloves such as Nitrile disposable gloves when handling Graffiti- ZAPT or any of the cleaners referenced above.

CAUTION: Always test graffiti cleaners in a small inconspicuous area to make sure they are compatible and do not damage the surface of the sign. Do not use abrasives or metal brushes on the surface of Direct Embed® signs.

Permanent marker, crayon, inks

1. Saturate a section of a shop rag with Graffiti-ZAPTM graffiti remover.
2. Working from the top of the sign down, rub the wet rag over the graffiti using a light, circular rubbing motion to remove it. If it begins to smear, select a clean saturated section of the rag and continue light rubbing until the graffiti is gone.

Paints

Paints must be dissolved and removed in layers; depending on thickness of the graffiti paint, it may require two or three applications of Graffiti-ZAPTM for complete paint removal

1. Working from the top of the sign down in 2 square foot sections, spray the paint graffiti with Graffiti-ZAPTM to thoroughly cover and wet the surface of the paint. Graffiti- ZAPTM is a mild solvent. Let it saturate the graffiti for one to two minutes before brushing or rubbing.
2. Using the small nylon brush included with your Graffiti-ZAPTM kit, begin brushing the surface of the paint in a straight back and forth motion, using light to medium pressure on the brush to loosen the paint. This back and forth motion cuts micro-grooves into the surface of the paint, increasing Graffiti-ZAP's ability to penetrate the paint and release its bond from the surface of the sign.
3. Saturate a shop rag with Graffiti-ZAPTM graffiti remover.

- Graffiti removal (continued)**
1. Using the saturated shoprag, begin rubbing it over the paint with firm pressure in a straight back and forth motion to remove the layers of paint that have been dissolved and/or loosened. Change the section of the saturated rag that is in contact with the sign frequently to avoid building up paint on the rag and smearing the sign. If stubborn paint layers remain, don't apply excess force to remove them. Let Graffiti-ZAPTM do the work.
 2. Spray the surface of the remaining paint with Graffiti-ZAPTM once again to thoroughly wet the remaining paint. Let it saturate the paint for one to two minutes.
 3. Using the small nylon brush, begin brushing the surface of the paint in a straight back and forth motion, using light to medium pressure on the brush to loosen the remaining paint.
 4. Using a clean, saturated section of the shop rag, begin rubbing it over the remaining paint with firm pressure in a straight back and forth motion to remove any existing paint. Change the section of the saturated rag frequently to avoid building up paint on the rag and smearing the sign. If necessary, repeat steps 5 through 7 until the paint is gone and the surface of the sign is clean.
 5. Repeat this process on all other sections of the sign damaged by graffiti
 6. Using a clean shop rag saturated with Graffiti-ZAPTM solvent cleaner, wipe down the entire sign to remove any paint or graffiti splatters that may exist.
 7. Wash the entire surface of the sign with soap and water to remove any remaining Graffiti-ZAPTM from the sign.

Maintenance Direct Embed® signs are relatively maintenance free due to the durability of these signs. Never-the-less, an occasional washing with mild soap and water will help retain the original color and vivid graphics on the sign.

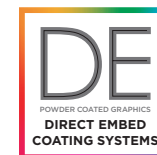

MAIN OFFICE

280 North Midland Ave
Building C-1, Unit 128
Saddle Brook, NJ. 07663

973-569-1111

directembedcoating.com

FLORIDA

1323 Mahan Drive, Suite 10
Tallahassee, FL 32308

300 SE 2nd Street, Suite 600
Fort Lauderdale, FL 3330

NEW YORK

56 West 45th Street, 2nd Floor
New York, NY 10026

